

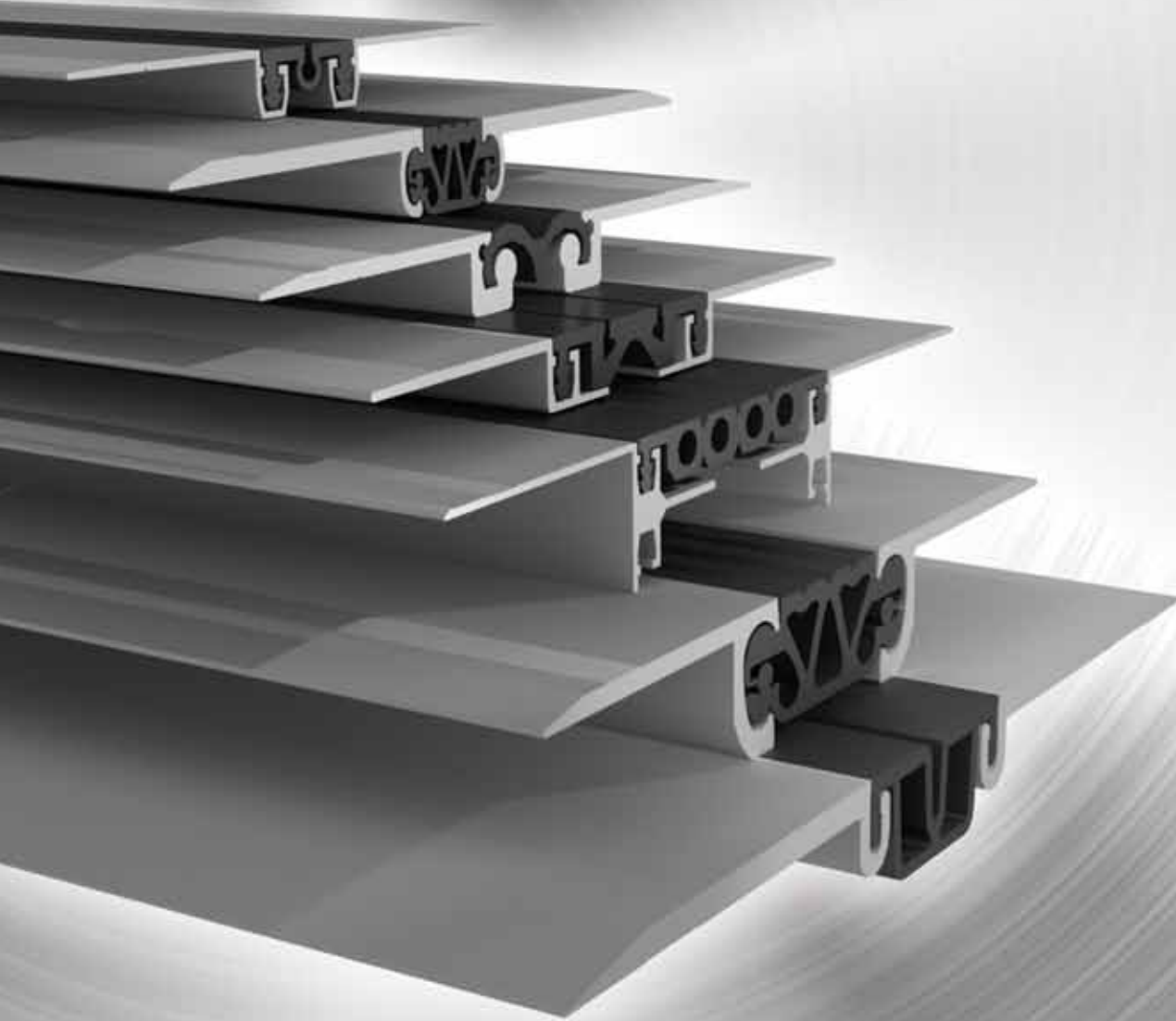

EKTA YAPI



TEKNİK ÜRÜN KATALOĞU



DOĞRU DİLATASYON PROFİLİ SEÇİMİ

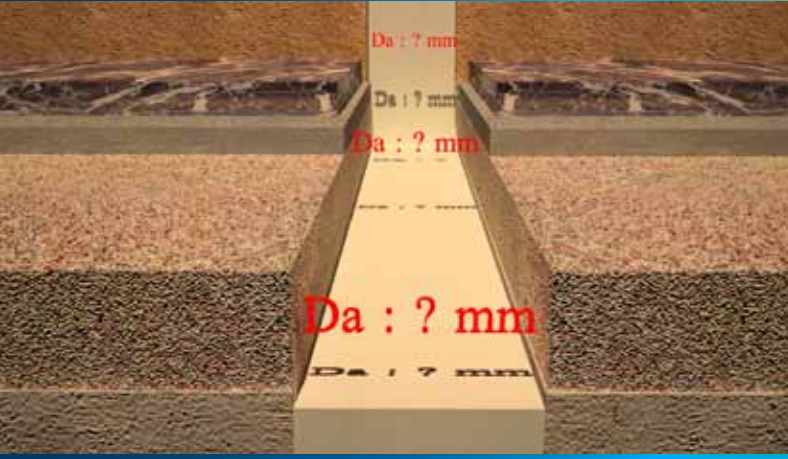

Dilatasyon Boşluğu ?

Yapının özelliğine göre dilatasyon boşluğu seçilir ve arasına eps yerleştirilir. doğru dilatasyon profili seçimi için dilatasyon boşluğunun ölçüsü bilinmelidir. Genellikle 30 mm, 50 mm, 80 mm ve 100 mm olmaktadır.

Kaplama Altı mı? Kaplama Üzeri mi ?

Döşemelerde kaplama altı dilatasyon profili kullanmak her zaman için daha uzun ömürlü ve sağlıklı çözüm olacaktır. Kaplama altı dilatasyon profillerinin kullanılmasına imkan olmadığı durumlar da kaplama üzeri dilatasyon profilleri kullanılmalıdır.

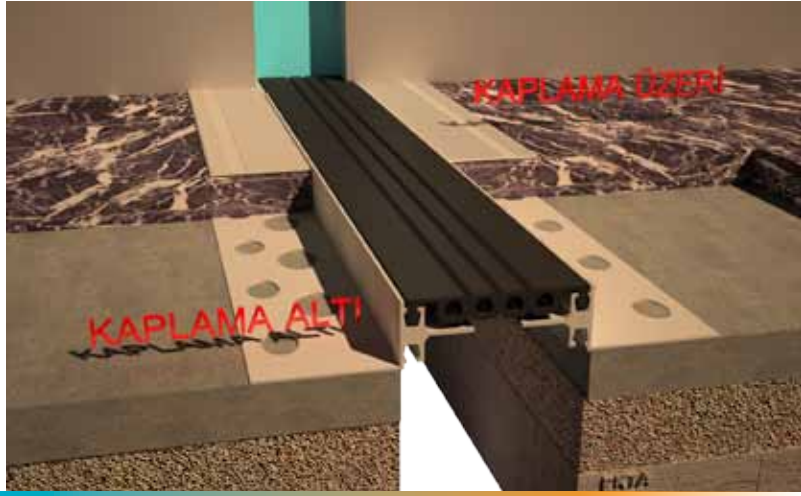

Kaplama Kalınlığı ?

Kaplama altı dilatasyon profili kullanılacak ise mevcut kaplamanın kalınlığı bilinmeli ve ona göre uygun yüksekliğe sahip dilatasyon profili seçilmez.

Yük Geçişi ?

Dilatasyon profillerinin üzerinden ne tarz yükler geçeceği bilinmelidir. Bu yüke dayanıklı dilatasyon profili seçilmez.



ZKA 50-15

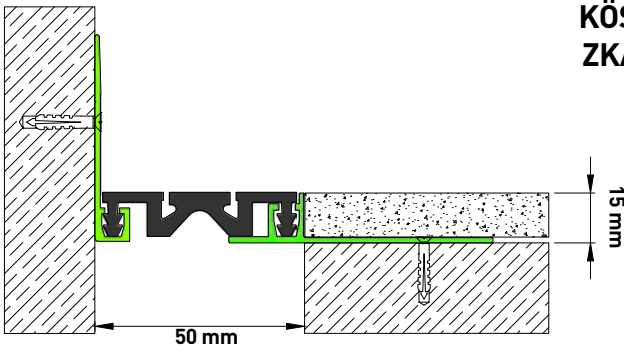
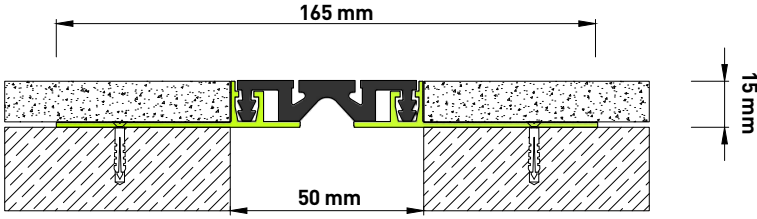

KÖŞE DETAYI
ZKA 50-15/K

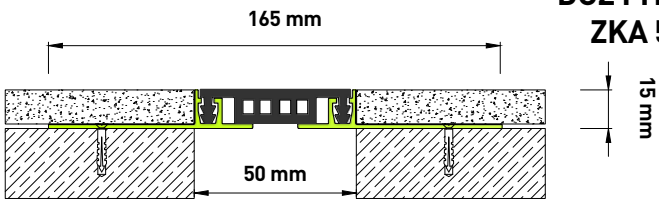

DÜZ FİTİL DETAYI
ZKA 50-15/D



PROFİL NO	DİLATASYON BOŞLUĞU	PROFİL YÜKSEKLİĞİ	YÜK KAPASİTESİ	HAREKET KAPASİTESİ	PROFİL GENİŞLİĞİ
ZKA 50-15	50 mm	15 mm		± 10 mm	165 mm

50 mm KAPLAMA ALTI ZEMİN DİLATASYON PROFİLİ



ZKA 50-35

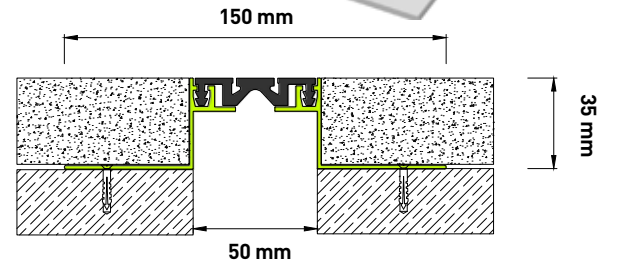
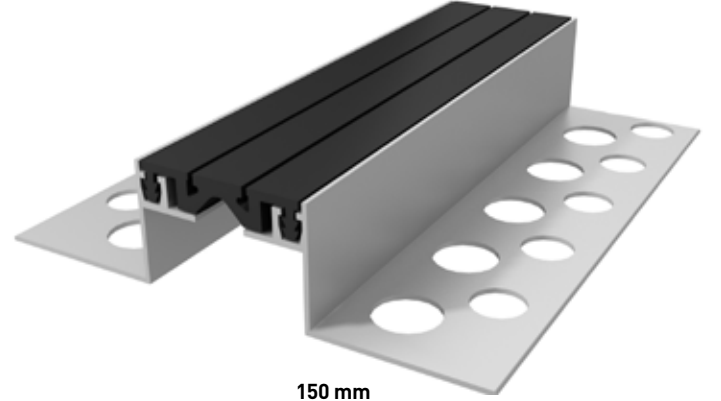
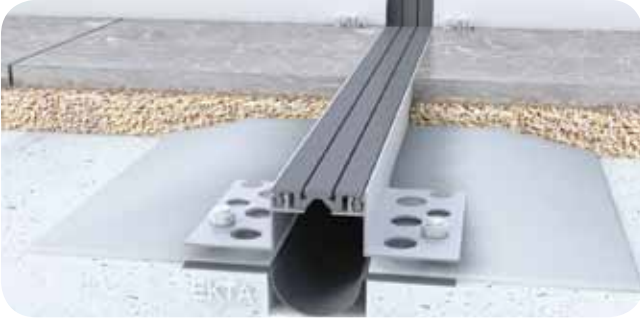
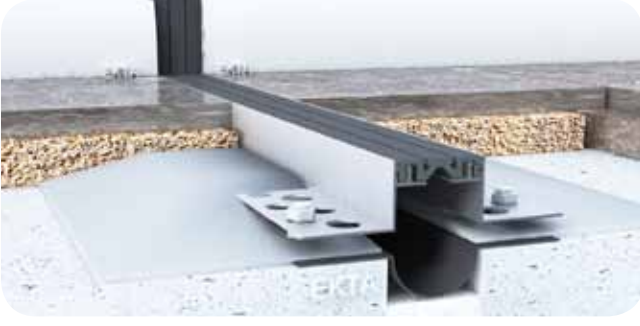

PROFİL NO	DİLATASYON BOŞLUĞU	PROFİL YÜKSEKLİĞİ	YÜK KAPASİTESİ	HAREKET KAPASİTESİ	PROFİL GENİŞLİĞİ
ZKA 50-35	50 mm	35 mm		± 10 mm	145 mm

50 mm KAPLAMA ALTI ZEMİN DİLATASYON PROFİLİ



ZKA 50-50

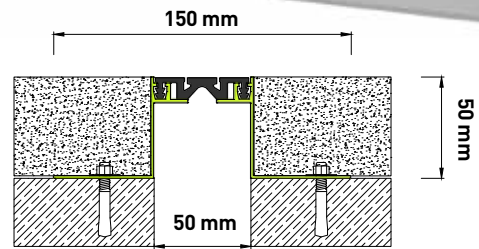
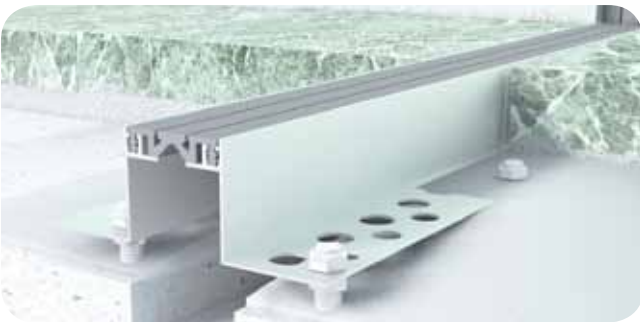
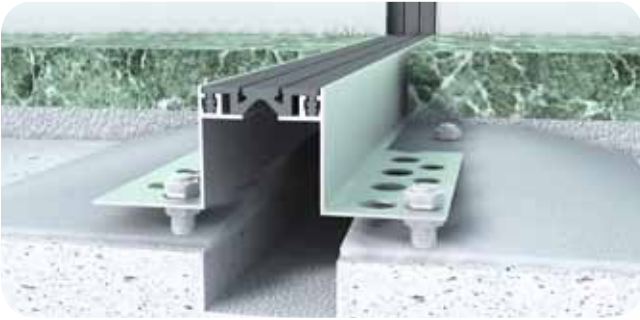

PROFİL NO	DİLATASYON BOŞLUĞU	PROFİL YÜKSEKLİĞİ	YÜK KAPASİTESİ	HAREKET KAPASİTESİ	PROFİL GENİŞLİĞİ
ZKA 50-50	50 mm	50 mm		± 10 mm	150 mm

60 mm KAPLAMA ALTI ZEMİN DİLATASYON PROFİLİ

ZKA 60-23

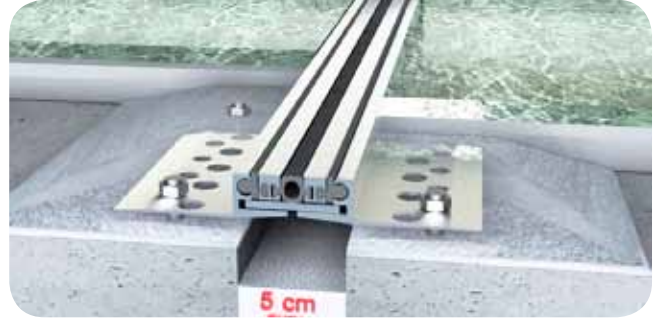
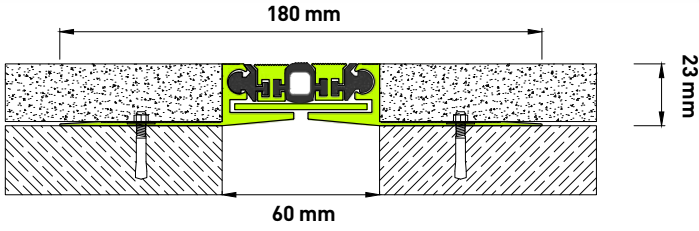

PROFİL NO	DİLATASYON BOŞLUĞU	PROFİL YÜKSEKLİĞİ	YÜK KAPASİTESİ	HAREKET KAPASİTESİ	PROFİL GENİŞLİĞİ
ZKA 60-23	60 mm	23 mm		± 5 mm	180 mm

60 mm KAPLAMA ALTI ZEMİN DİLATASYON PROFİLİ

ZKA 60-43

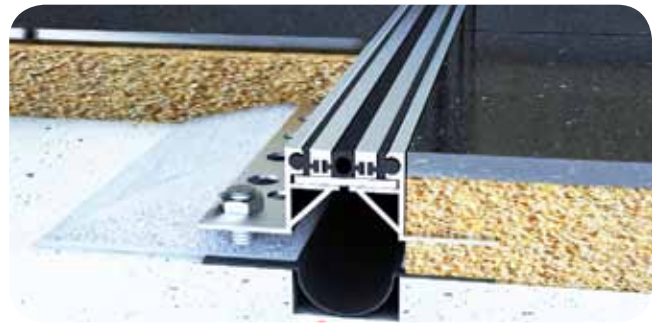
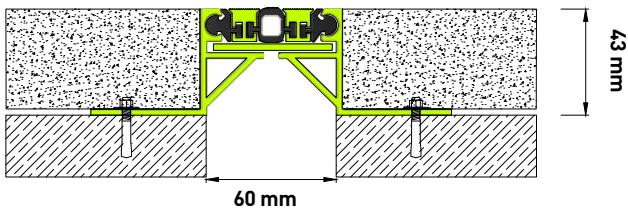
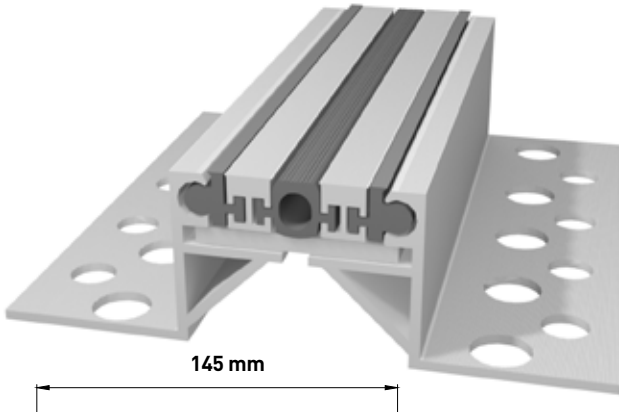

PROFİL NO	DİLATASYON BOŞLUĞU	PROFİL YÜKSEKLİĞİ	YÜK KAPASİTESİ	HAREKET KAPASİTESİ	PROFİL GENİŞLİĞİ
ZKA 60-43	60 mm	43 mm		± 5 mm	145 mm



ZKU 50-15

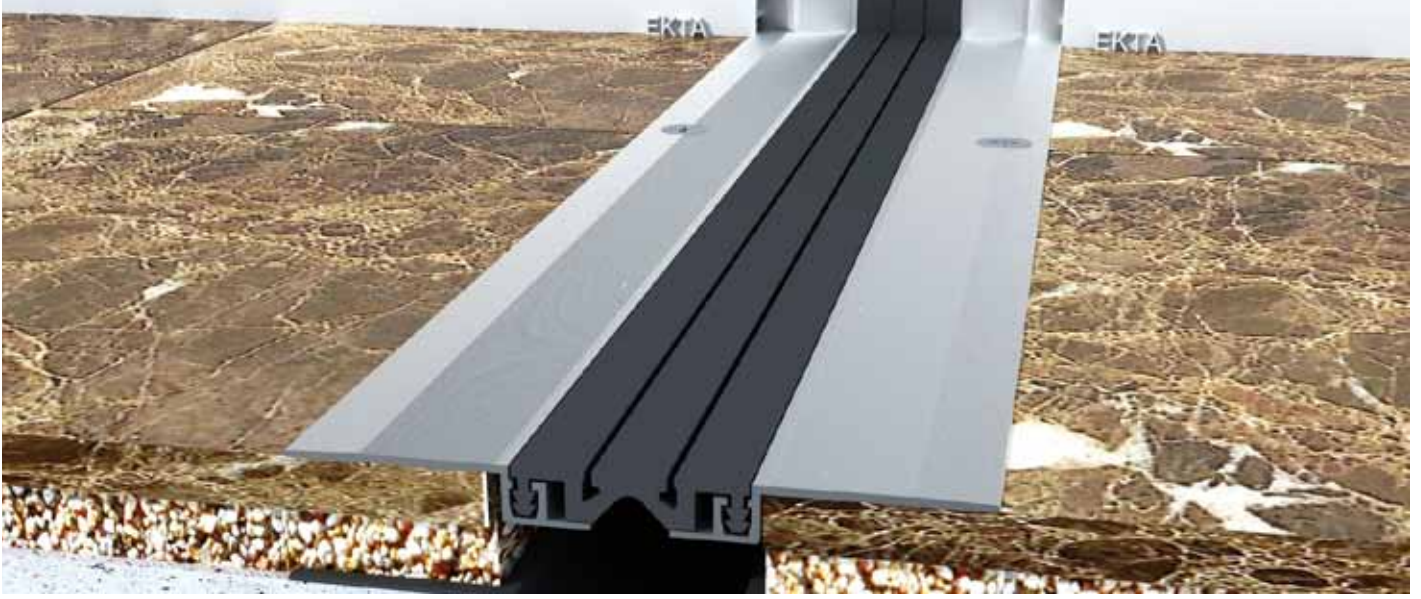

ZKU 50-15

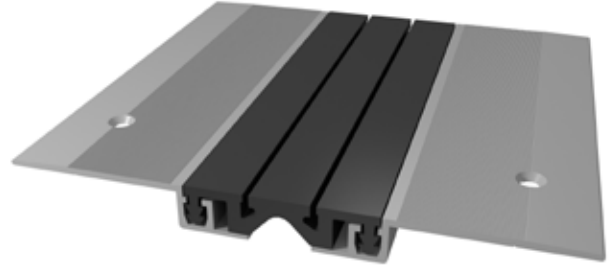
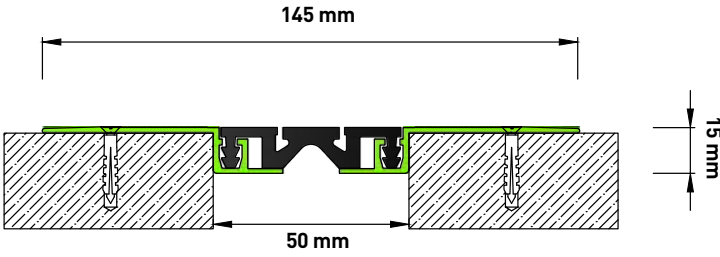

KÖŞE DETAYI ZKU 50-15/K

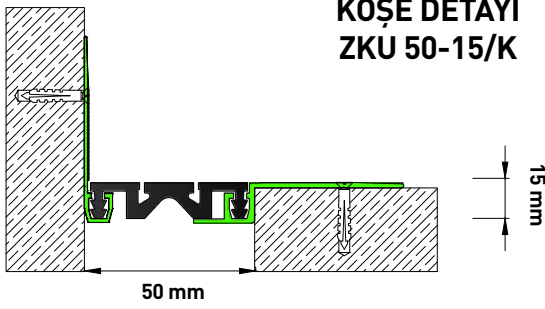

DÜZ FİTİL DETAYI ZKU 50-15/D

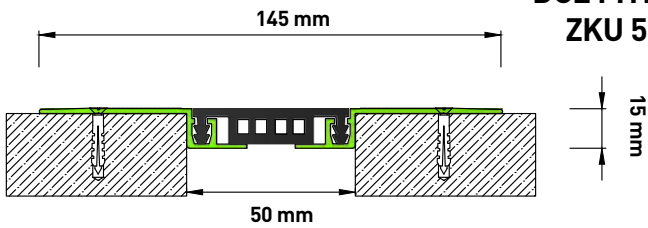

PROFİL NO	DİLATASYON BOŞLUĞU	PROFİL YÜKSEKLİĞİ	YÜK KAPASİTESİ	HAREKET KAPASİTESİ	PROFİL GENİŞLİĞİ
ZKU 50-15	50 mm	15 mm		± 10 mm	145 mm

50 mm KAPLAMA ÜZERİ ZEMİN DİLATASYON PROFİLİ

ZKU 50-19

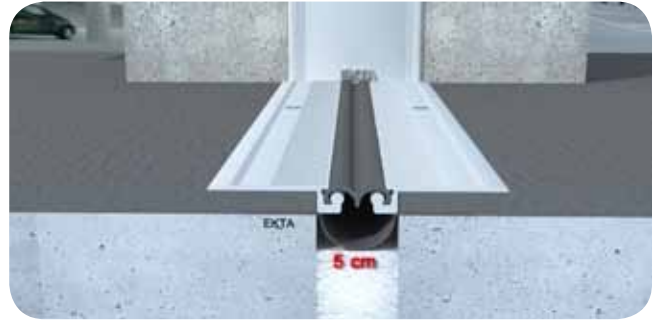
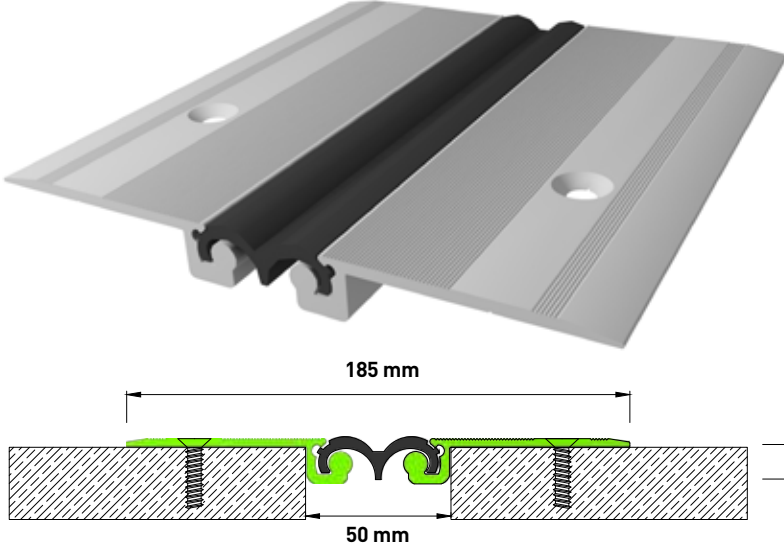

PROFİL NO	DİLATASYON BOŞLUĞU	PROFİL YÜKSEKLİĞİ	YÜK KAPASİTESİ	HAREKET KAPASİTESİ	PROFİL GENİŞLİĞİ
ZKU 50-19	50 mm	19 mm		± 12 mm	185 mm

50 mm KAPLAMA ÜZERİ ZEMİN DİLATASYON PROFİLİ

ZKU 50-20

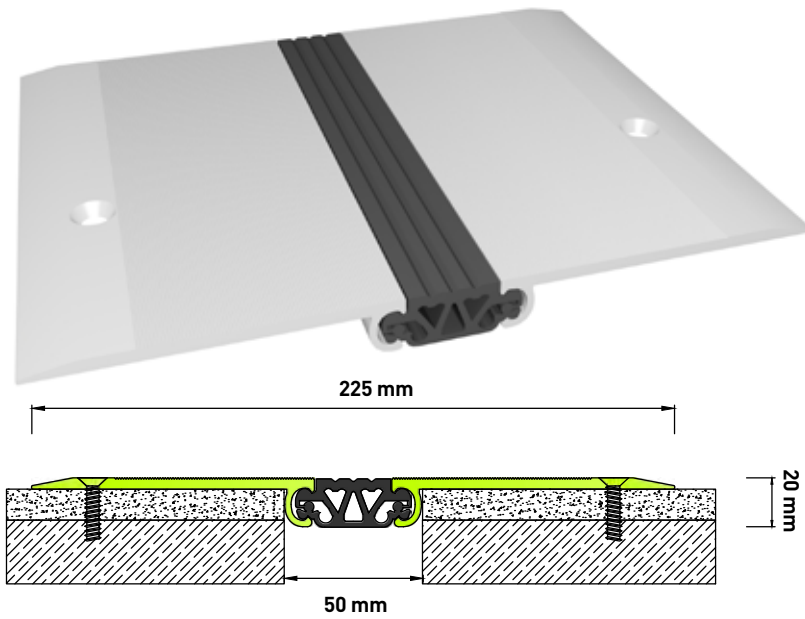

PROFİL NO	DİLATASYON BOŞLUĞU	PROFİL YÜKSEKLİĞİ	YÜK KAPASİTESİ	HAREKET KAPASİTESİ	PROFİL GENİŞLİĞİ
ZKU 50-20	50 mm	20 mm		± 20 mm	255mm



DKU 50-14

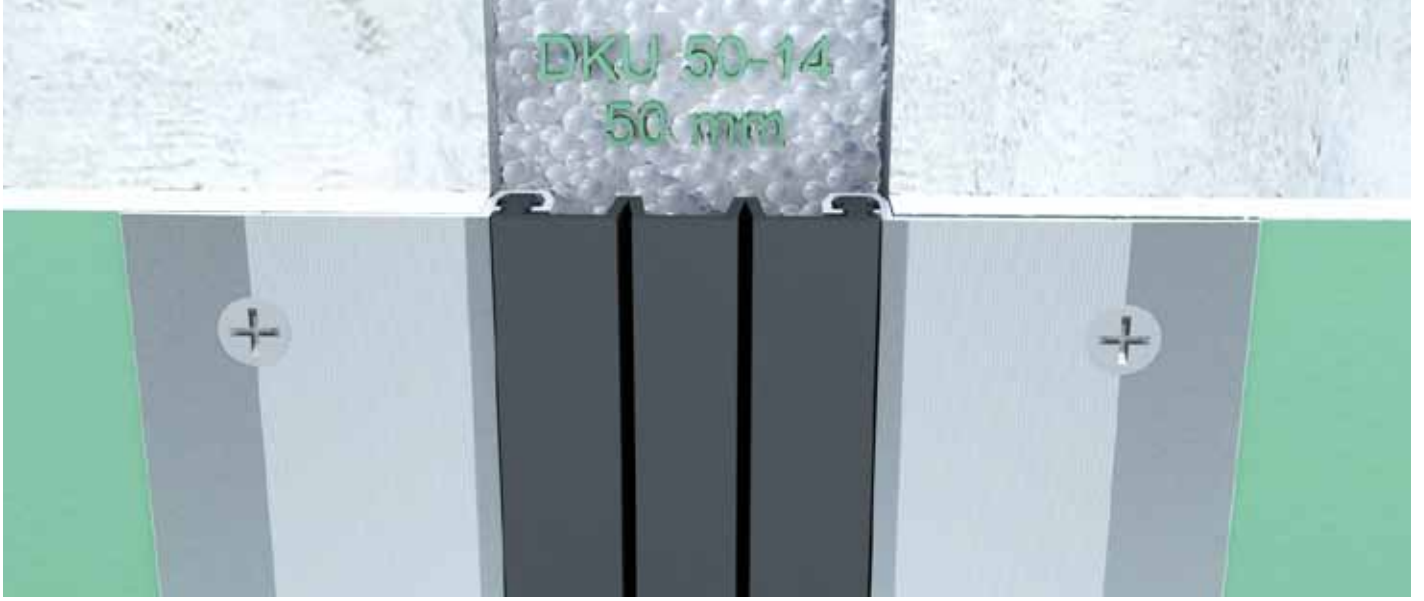

DKU 50-14

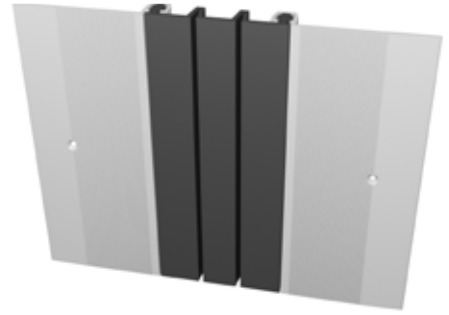
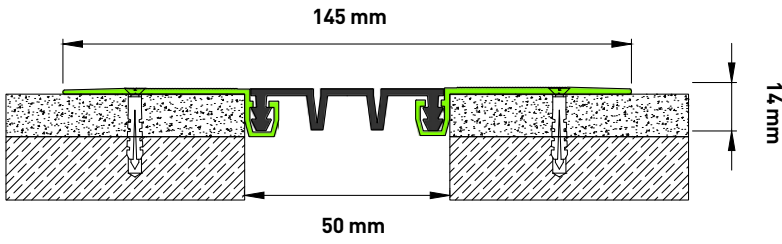

KÖŞE DETAYI DKU 50-14 / K

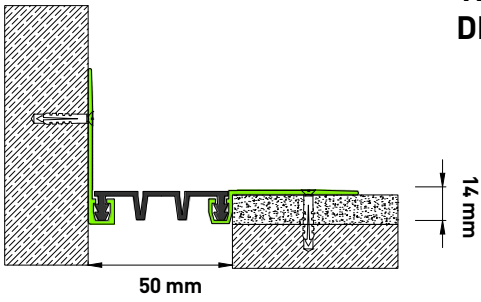

DÜZ FİTİL DETAYI DKU 50-14/D

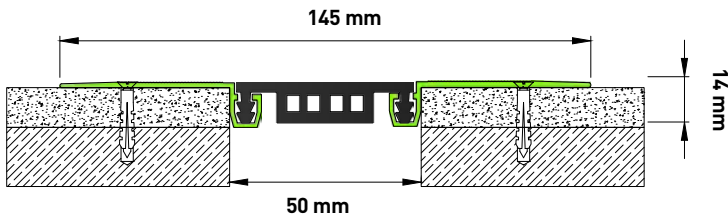

DİLATASYON BOŞLUĞU	PROFİL YÜKSEKLİĞİ	HAREKET KAPASİTESİ	PROFİL GENİŞLİĞİ
50 mm	14 mm	± 8 mm	145 mm

DKA 50-14

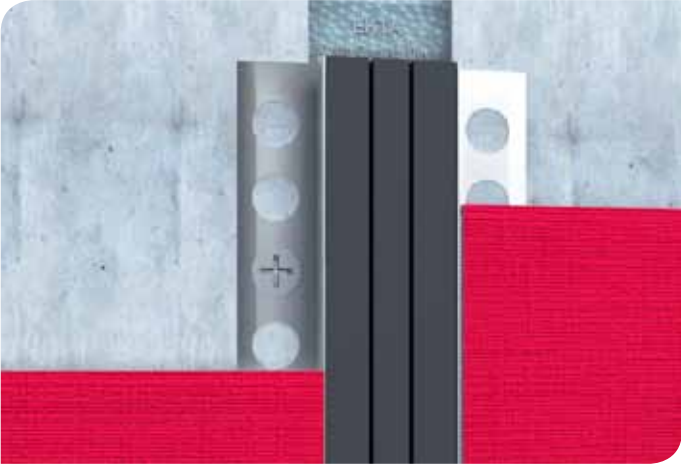
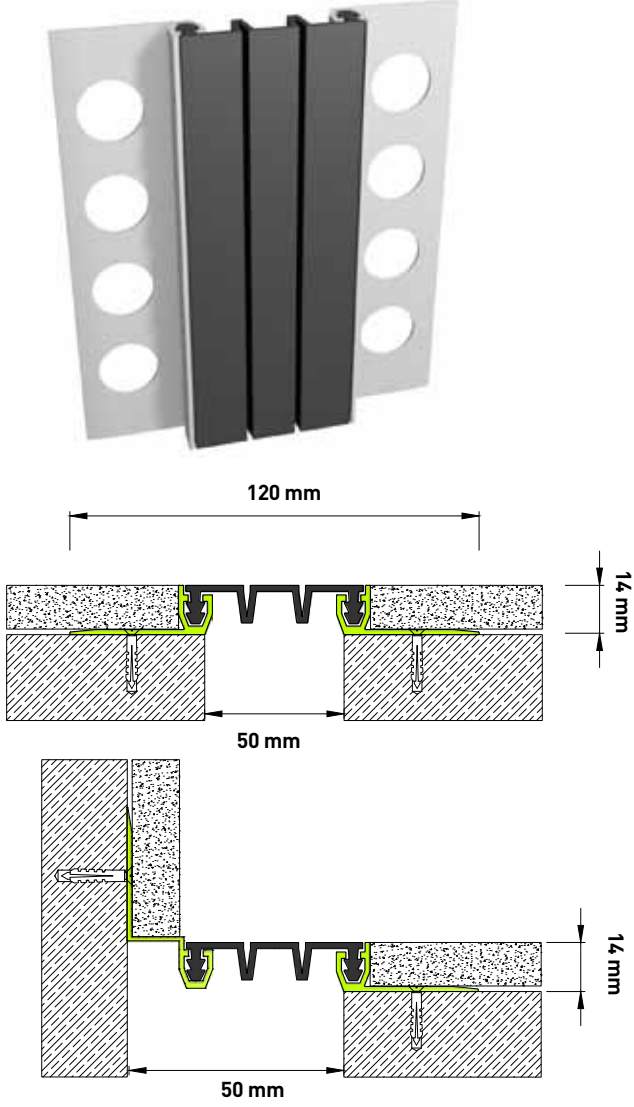

DİLASYON BOŞLUĞU	PROFİL YÜKSEKLİĞİ	HAREKET KAPASİTESİ	PROFİL GENİŞLİĞİ
50 mm	14 mm	± 15 mm	145 mm

DKA 50-19

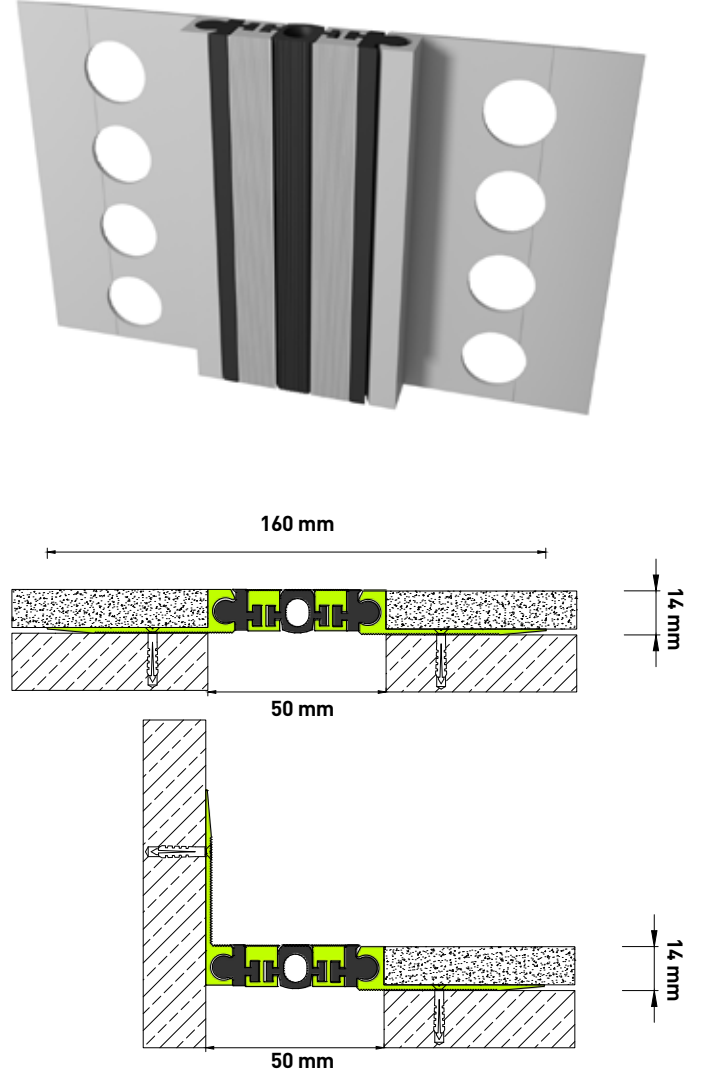

DİLASYON BOŞLUĞU	PROFİL YÜKSEKLİĞİ	HAREKET KAPASİTESİ	PROFİL GENİŞLİĞİ
50 mm	14 mm	± 8 mm	160 mm

30 mm KAPLAMA ÜZERİ ZEMİN DİLATASYON PROFİLİ



ZKA 30-14

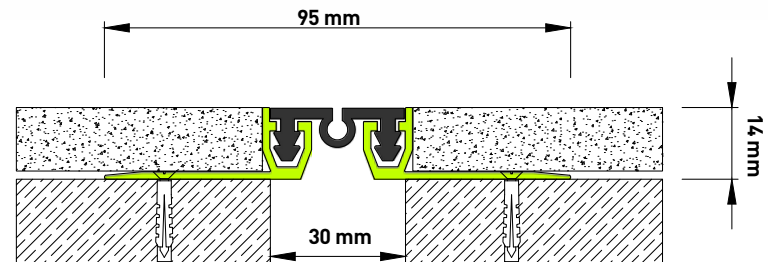

PROFİL NO	DİLATASYON BOŞLUĞU	PROFİL YÜKSEKLİĞİ	YÜK KAPASİTESİ	HAREKET KAPASİTESİ	PROFİL GENİŞLİĞİ
ZKA 30-14	30 mm	14 mm		± 9 mm	95 mm

30 mm KAPLAMA ÜZERİ ZEMİN DİLATASYON PROFİLİ



ZKA 30-19

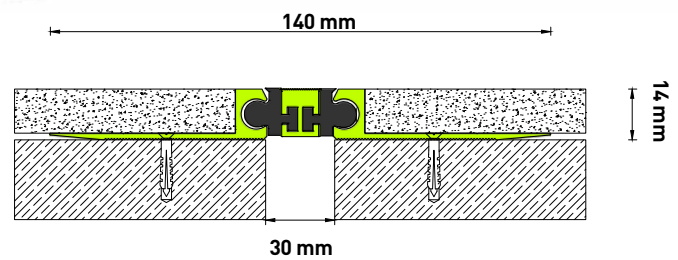
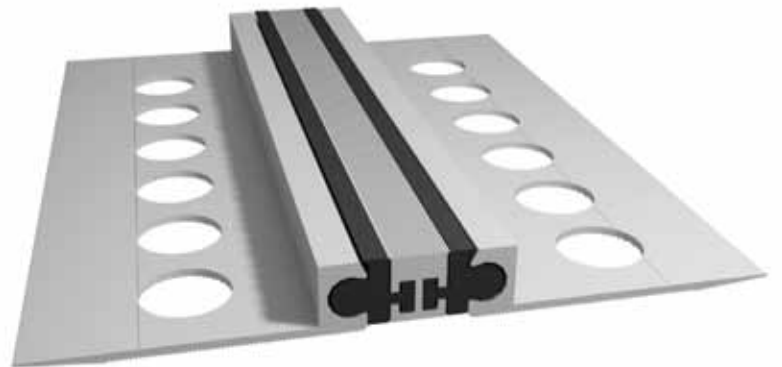

PROFİL NO	DİLATASYON BOŞLUĞU	PROFİL YÜKSEKLİĞİ	YÜK KAPASİTESİ	HAREKET KAPASİTESİ	PROFİL GENİŞLİĞİ
ZKA 30-19	30 mm	14 mm		± 4 mm	140 mm

30 mm KAPLAMA ALTI ZEMİN DİLATASYON PROFİLİ

ZKU 30-35

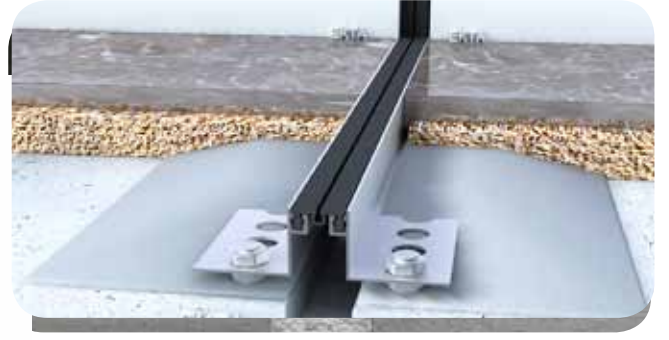
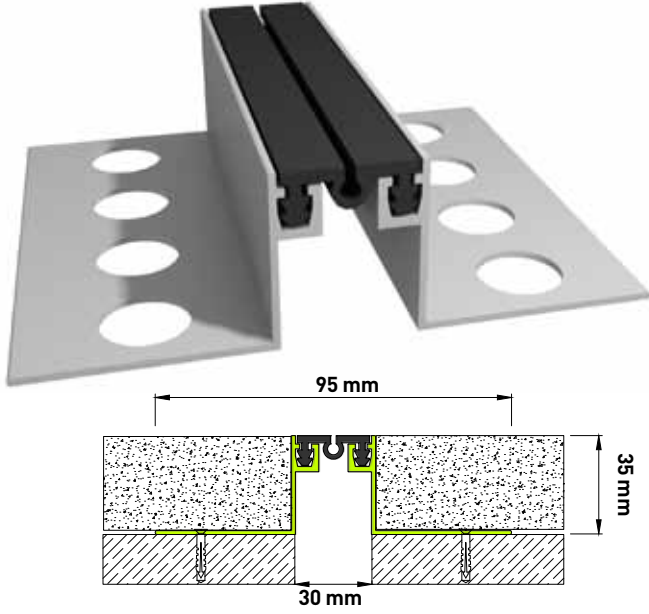

PROFİL NO	DİLATASYON BOŞLUĞU	PROFİL YÜKSEKLİĞİ	YÜK KAPASİTESİ	HAREKET KAPASİTESİ	PROFİL GENİŞLİĞİ
ZKA 30-35	30 mm	35 mm		± 9 mm	95 mm

30 mm KAPLAMA ALTI ZEMİN DİLATASYON PROFİLİ

ZKA 30-50

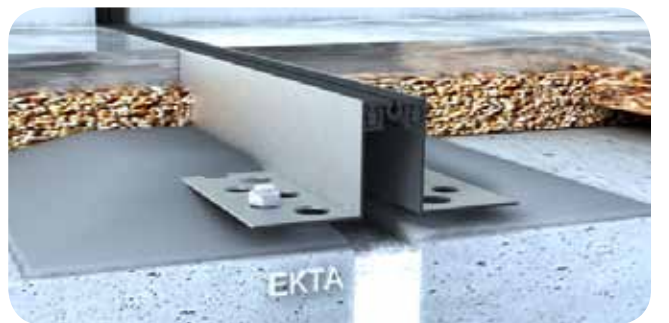
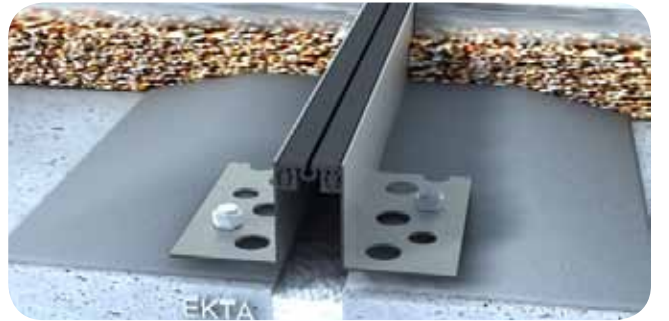
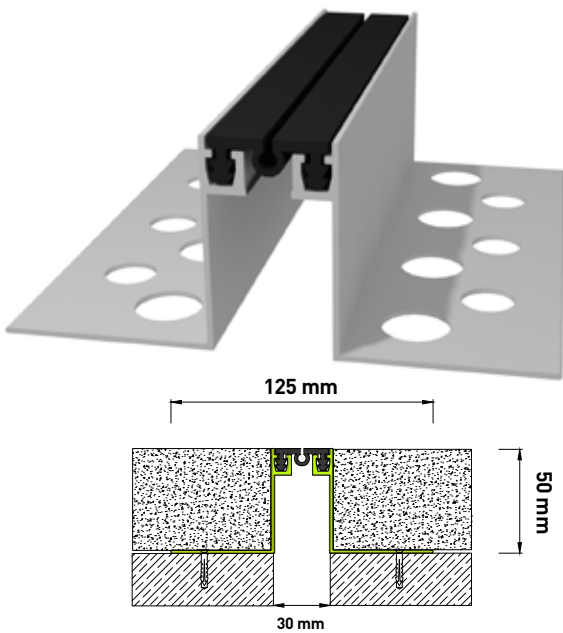

PROFİL NO	DİLATASYON BOŞLUĞU	PROFİL YÜKSEKLİĞİ	YÜK KAPASİTESİ	HAREKET KAPASİTESİ	PROFİL GENİŞLİĞİ
ZKA 30-50	30 mm	50 mm		± 9 mm	125 mm

30 mm KAPLAMA ÜZERİ ZEMİN DİLATASYON PROFİLİ

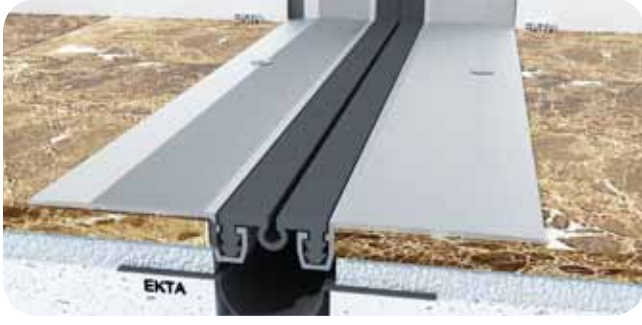

ZKU 30-14

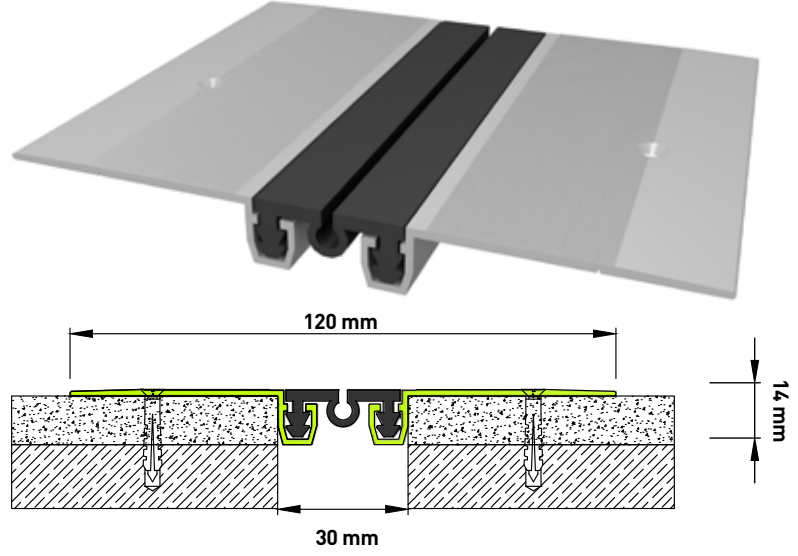

PROFİL NO	DİLATASYON BOŞLUĞU	PROFİL YÜKSEKLİĞİ	YÜK KAPASİTESİ	HAREKET KAPASİTESİ	PROFİL GENİŞLİĞİ
ZKU 30-14	30 mm	14 mm		± 9 mm	120 mm

30 mm KAPLAMA ÜZERİ ZEMİN DİLATASYON PROFİLİ

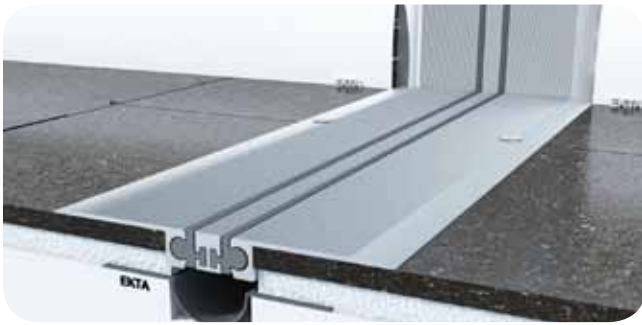

ZKU 30-19

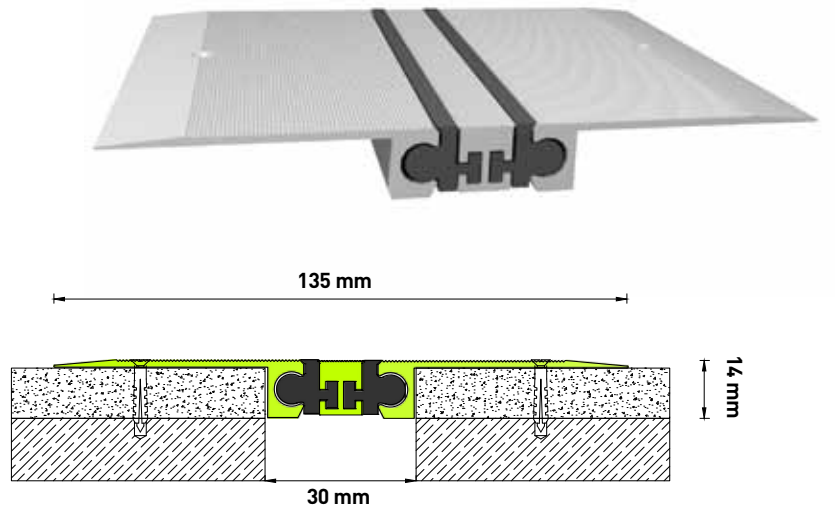

PROFİL NO	DİLATASYON BOŞLUĞU	PROFİL YÜKSEKLİĞİ	YÜK KAPASİTESİ	HAREKET KAPASİTESİ	PROFİL GENİŞLİĞİ
ZKU 30-19	30 mm	14 mm		± 5 mm	135 mm

DKU 30-14

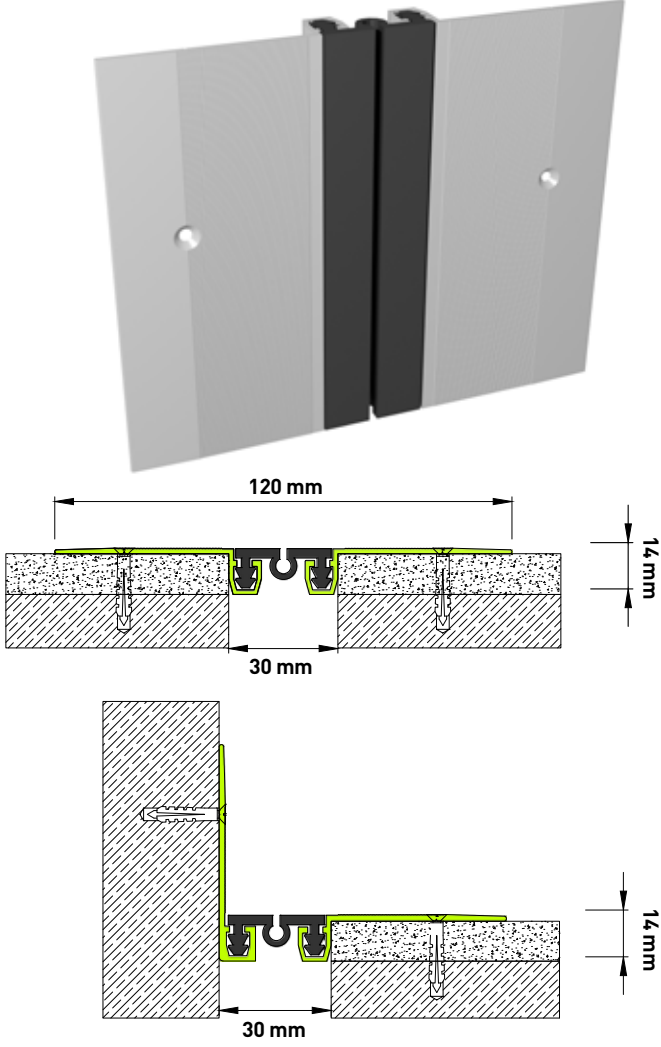

PROFİLLER 45 CM ARALIKLI HAVŞA BAŞ VİDA DELİKLİDİR, İSTEĞE BAĞLI ELOKSAL VEYA BOYA YAPILABİLİR.

DİLASYON BOŞLUĞU	PROFİL YÜKSEKLİĞİ	HAREKET KAPASİTESİ	PROFİL GENİŞLİĞİ
30 mm	14 mm	± 9 mm	120 mm

DKU 30-19

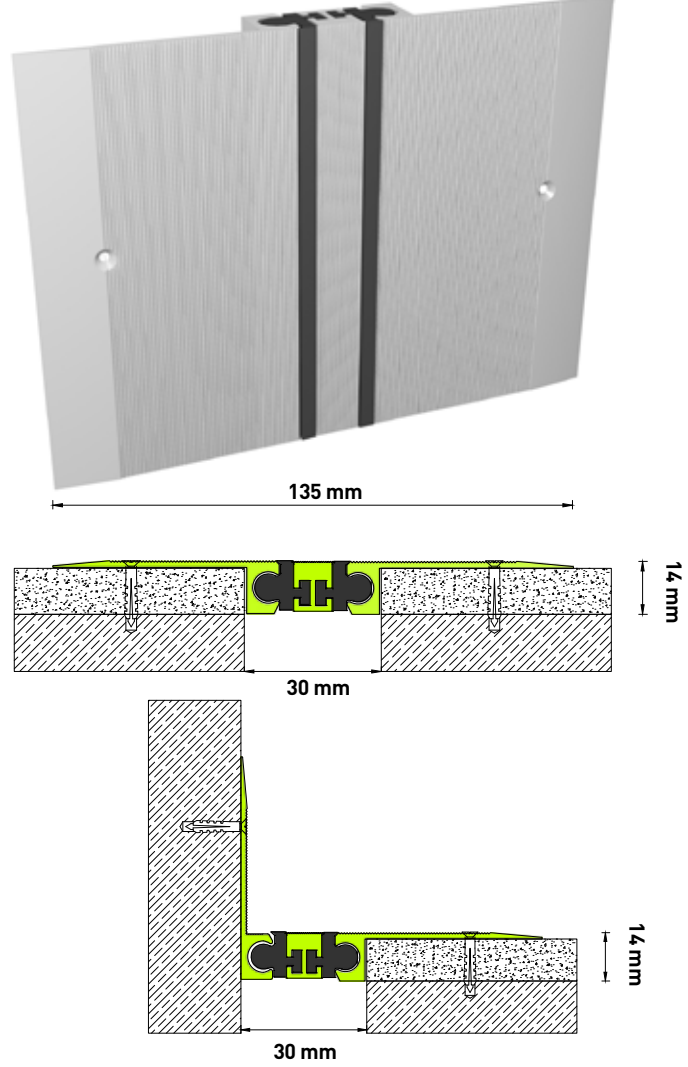

PROFİLLER 45 CM ARALIKLI HAVŞA BAŞ VİDA DELİKLİDİR, İSTEĞE BAĞLI ELOKSAL VEYA BOYA YAPILABİLİR.

DİLASYON BOŞLUĞU	PROFİL YÜKSEKLİĞİ	HAREKET KAPASİTESİ	PROFİL GENİŞLİĞİ
30 mm	14 mm	± 4 mm	145 mm



DKA30-14

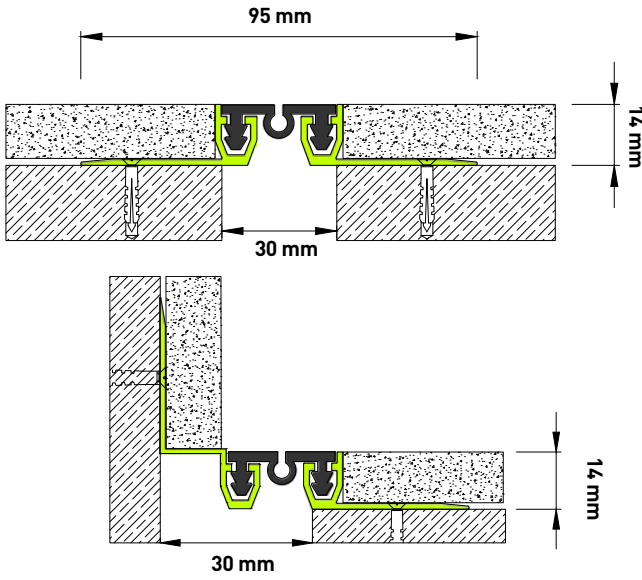

DİLATASYON BOŞLUĞU	PROFİL YÜKSEKLİĞİ	HAREKET KAPASİTESİ	PROFİL GENİŞLİĞİ
30 mm	14 mm	± 9 mm	95 mm

DKA 30-19

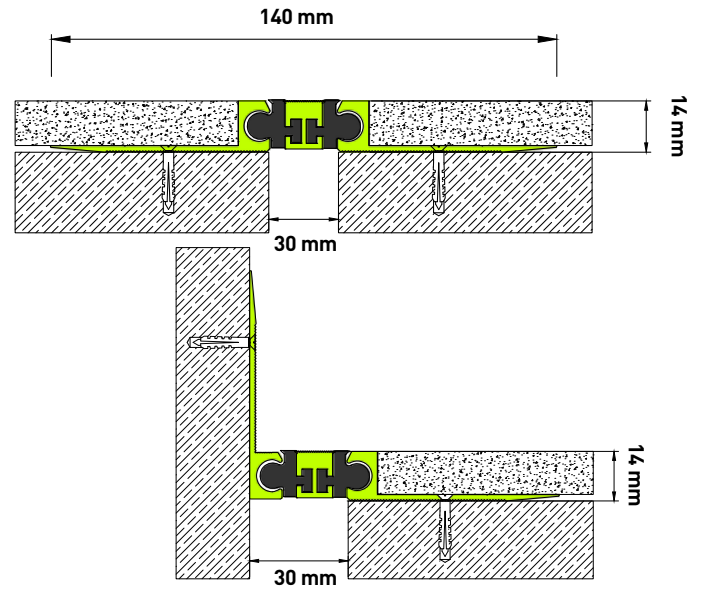
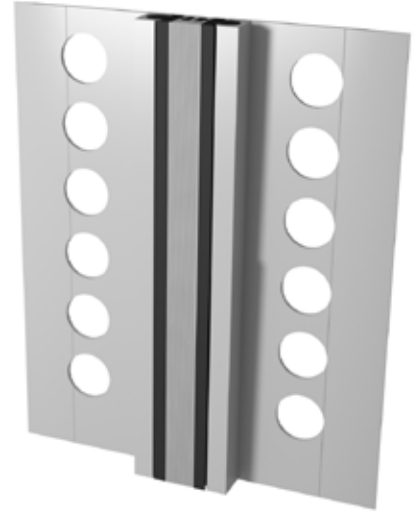

DİLATASYON BOŞLUĞU	PROFİL YÜKSEKLİĞİ	HAREKET KAPASİTESİ	PROFİL GENİŞLİĞİ
30 mm	14 mm	± 4 mm	140 mm

80 mm KAPLAMA ALTI ZEMİN DİLATASYON PROFİLİ

ZKA 80-15

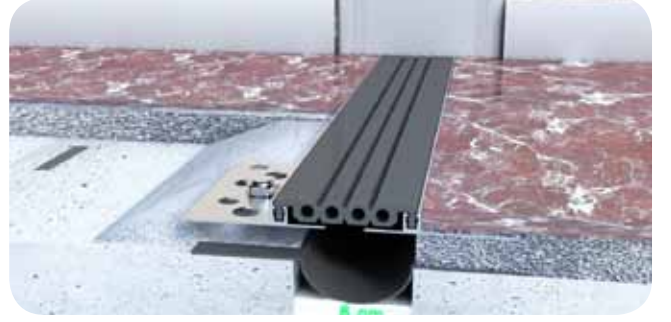
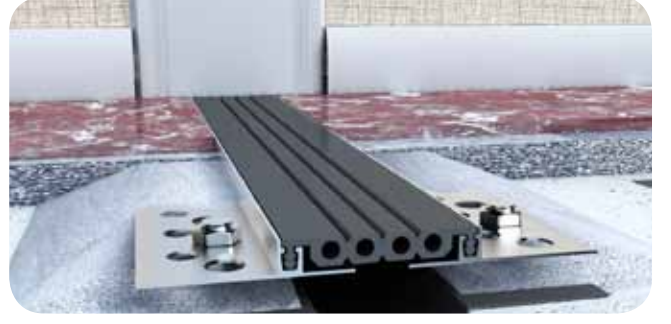
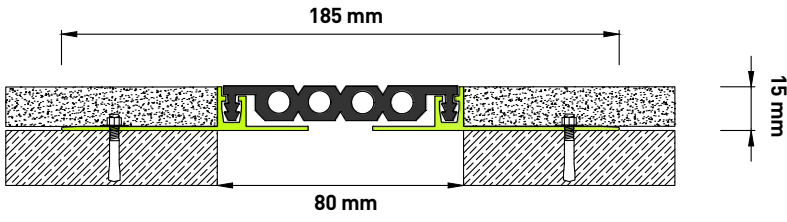
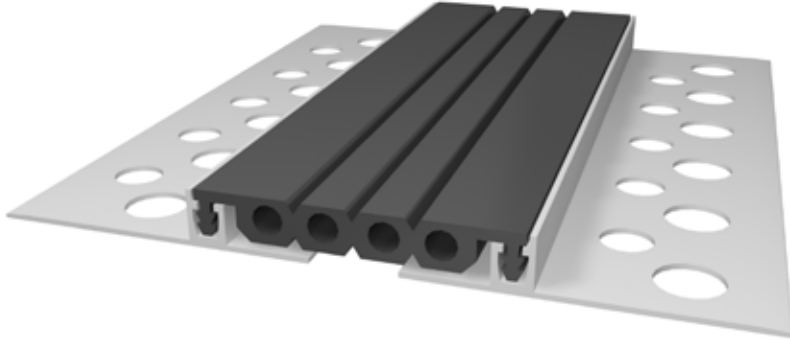

PROFİL NO	DİLATASYON BOŞLUĞU	PROFİL YÜKSEKLİĞİ	YÜK KAPASİTESİ	HAREKET KAPASİTESİ	PROFİL GENİŞLİĞİ
ZKA 80-15	80 mm	15 mm		± 11 mm	185 mm

80 mm KAPLAMA ALTI ZEMİN DİLATASYON PROFİLİ

ZKA 80-35

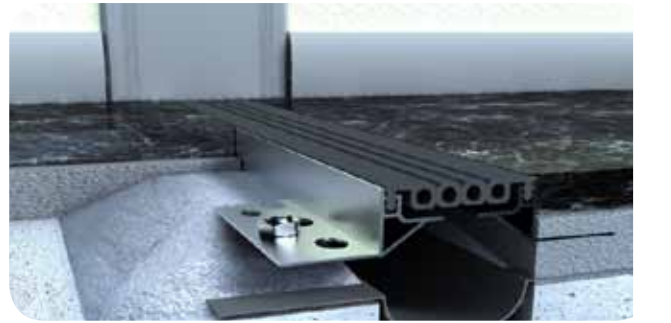
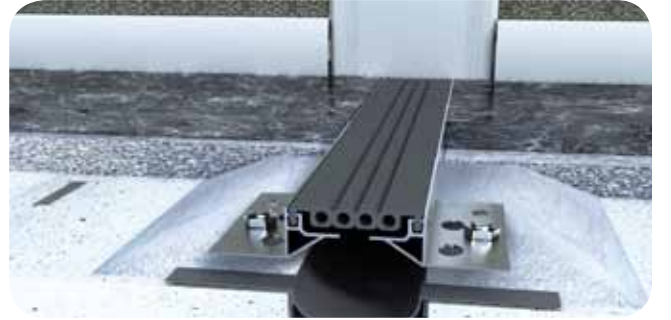
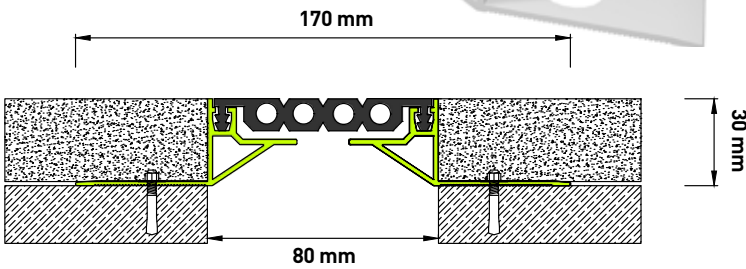
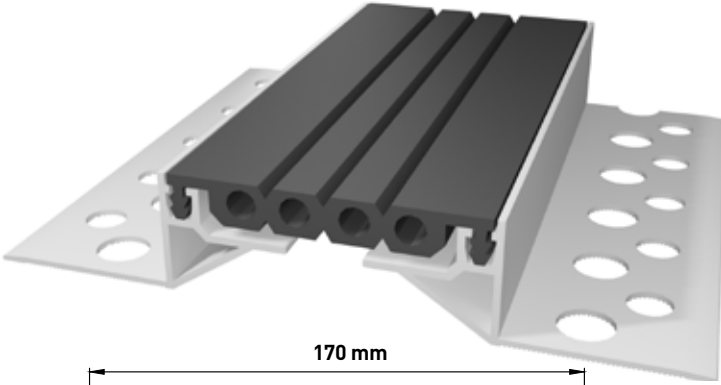

PROFİL NO	DİLATASYON BOŞLUĞU	PROFİL YÜKSEKLİĞİ	YÜK KAPASİTESİ	HAREKET KAPASİTESİ	PROFİL GENİŞLİĞİ
ZKA 80-30	80 mm	30 mm		± 11 mm	170 mm

80 mm KAPLAMA ÜZERİ ZEMİN DİLATASYON PROFİLİ

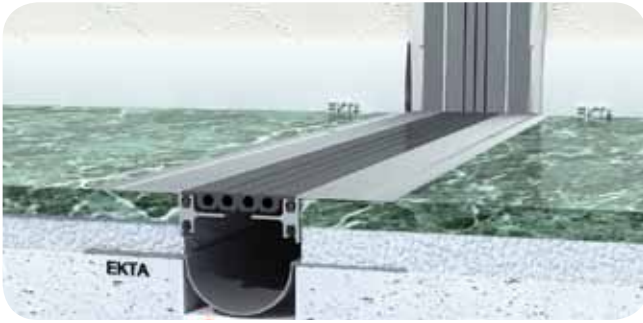
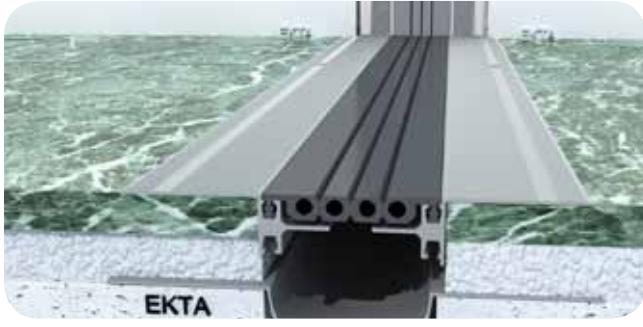

ZKU 80-30

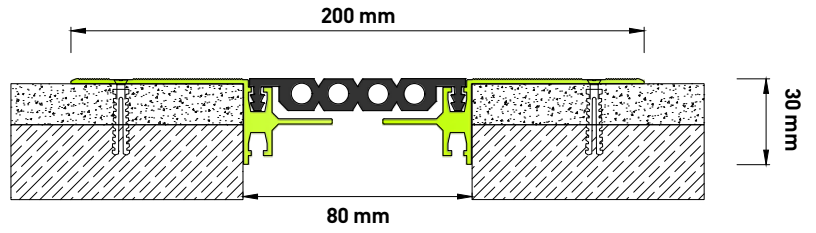
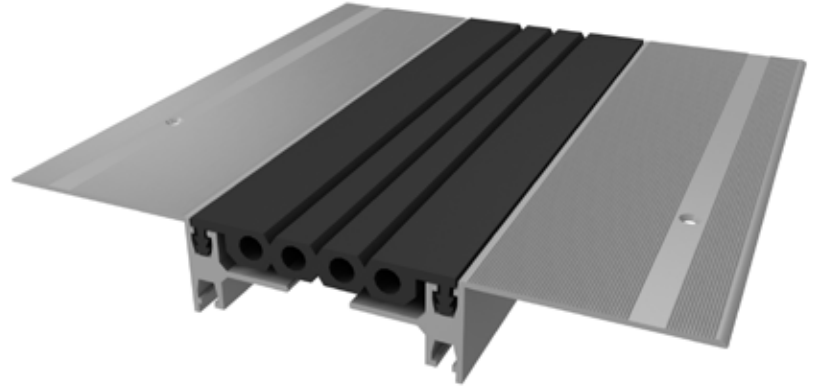

PROFİL NO	DİLATASYON BOŞLUĞU	PROFİL YÜKSEKLİĞİ	YÜK KAPASİTESİ	HAREKET KAPASİTESİ	PROFİL GENİŞLİĞİ
ZKU 80-30	80 mm	30 mm		± 10 mm	200 mm

80 mm KAPLAMA ÜZERİ ZEMİN DİLATASYON PROFİLİ

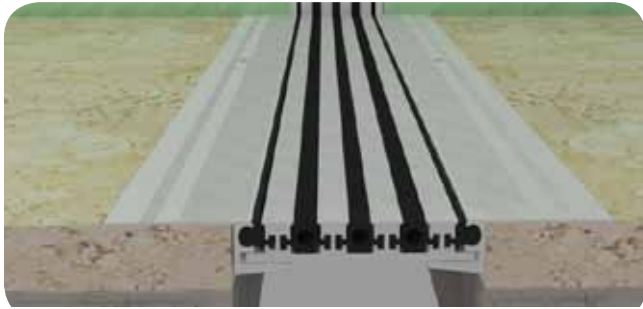

ZKU 80-23

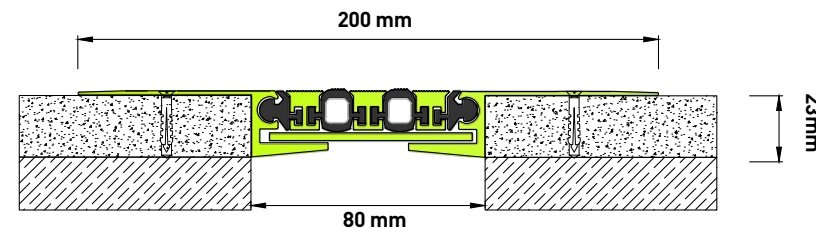
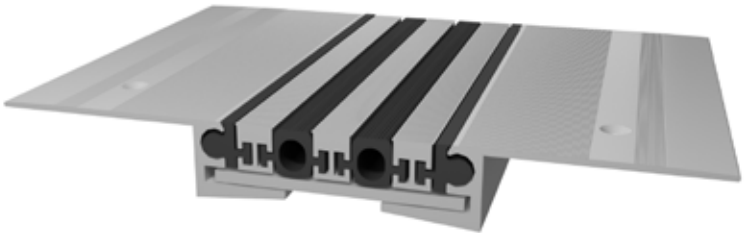

PROFİL NO	DİLATASYON BOŞLUĞU	PROFİL YÜKSEKLİĞİ	YÜK KAPASİTESİ	HAREKET KAPASİTESİ	PROFİL GENİŞLİĞİ
ZKU 80-23	50 mm	43 mm		± 9 mm	150 mm

DKA 80-14

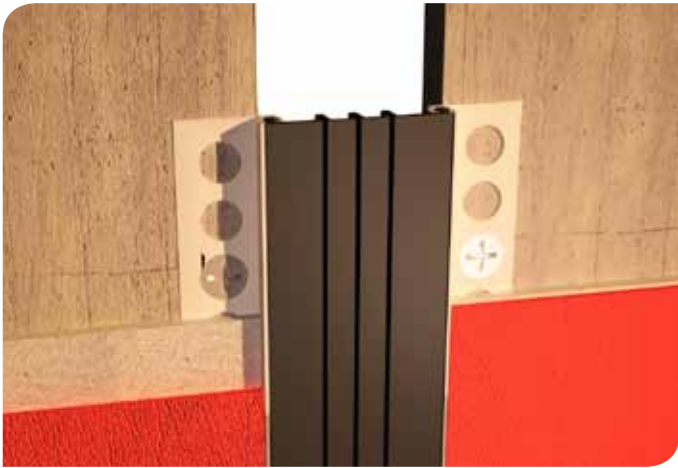
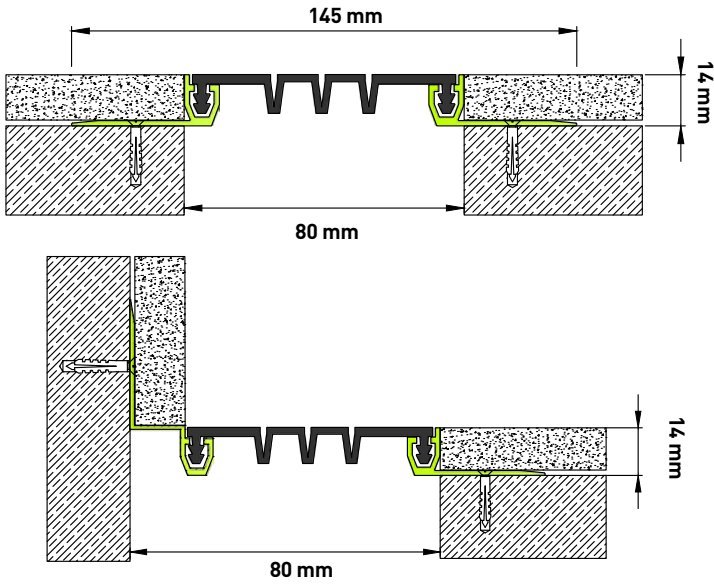

DİLATASYON BOŞLUĞU	PROFİL YÜKSEKLİĞİ	HAREKET KAPASİTESİ	PROFİL GENİŞLİĞİ
80 mm	14 mm	30 mm	145 mm

DKA 80-19

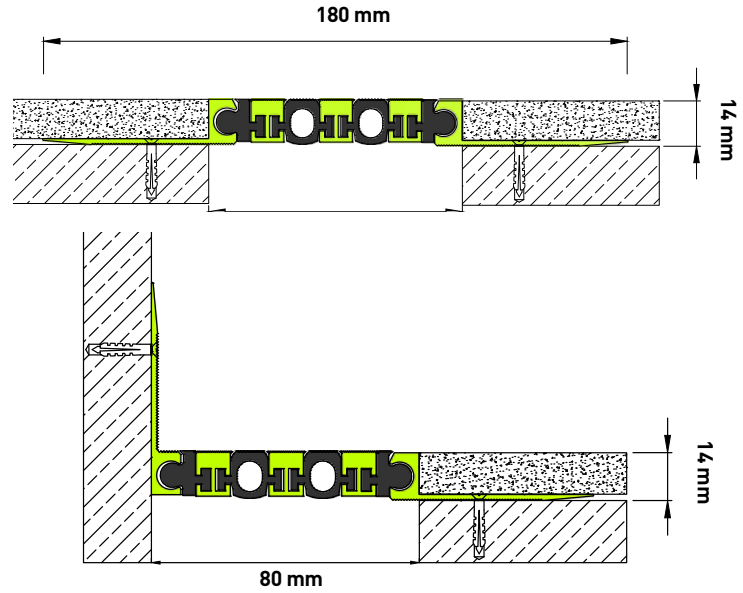
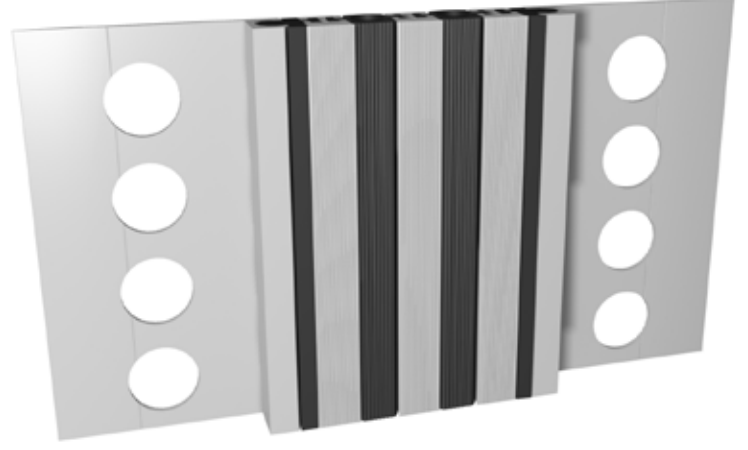

DİLATASYON BOŞLUĞU	PROFİL YÜKSEKLİĞİ	HAREKET KAPASİTESİ	PROFİL GENİŞLİĞİ
80 mm	14 mm	± 9 mm	180 mm



DKU 80-14

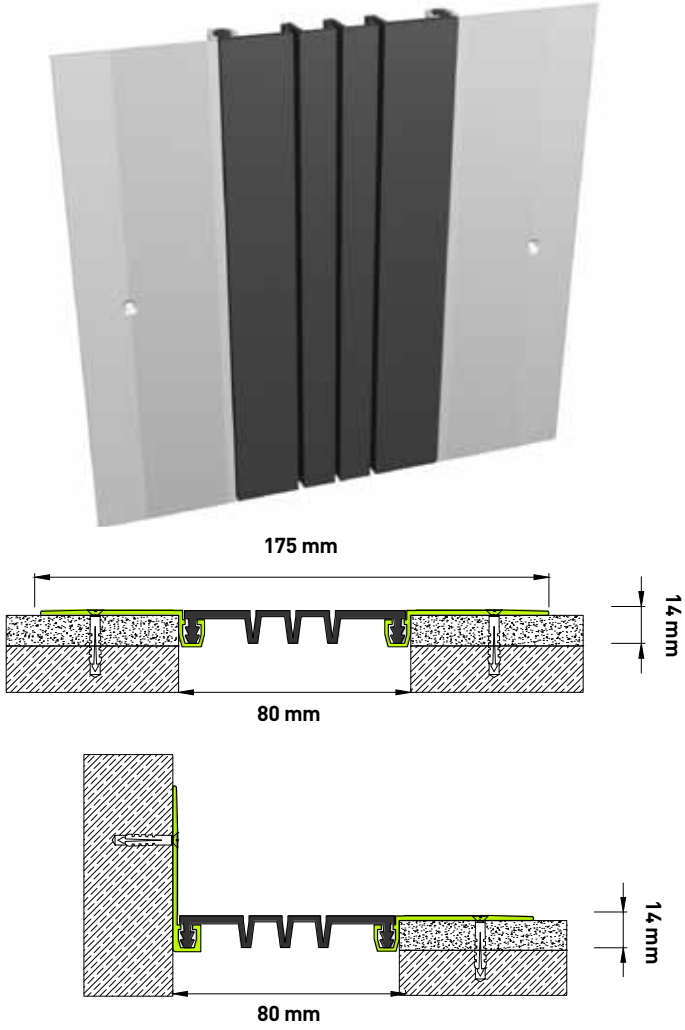

PROFİLLER 45 CM ARALIKLI HAVŞA BAŞ VİDA DELİKLİDİR, İSTEĞE BAĞLI ELOKSAL VEYA BOYA YAPILABİLİR.

DİLATASYON BOŞLUĞU	PROFİL YÜKSEKLİĞİ	HAREKET KAPASİTESİ	PROFİL GENİŞLİĞİ
80 mm	14 mm	± 30 mm	175 mm

DKU 80-19

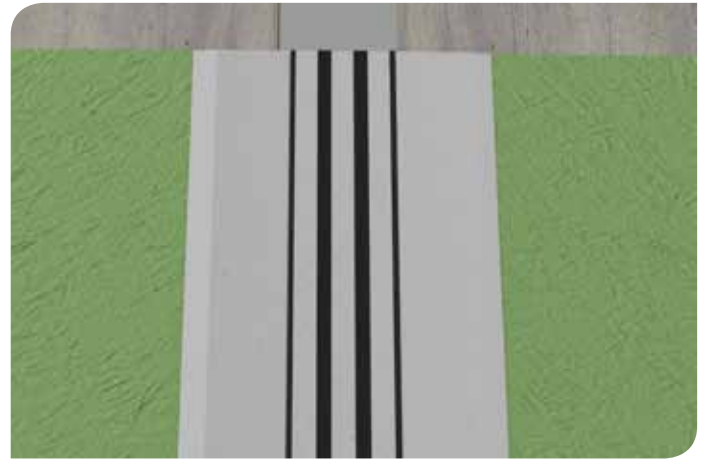
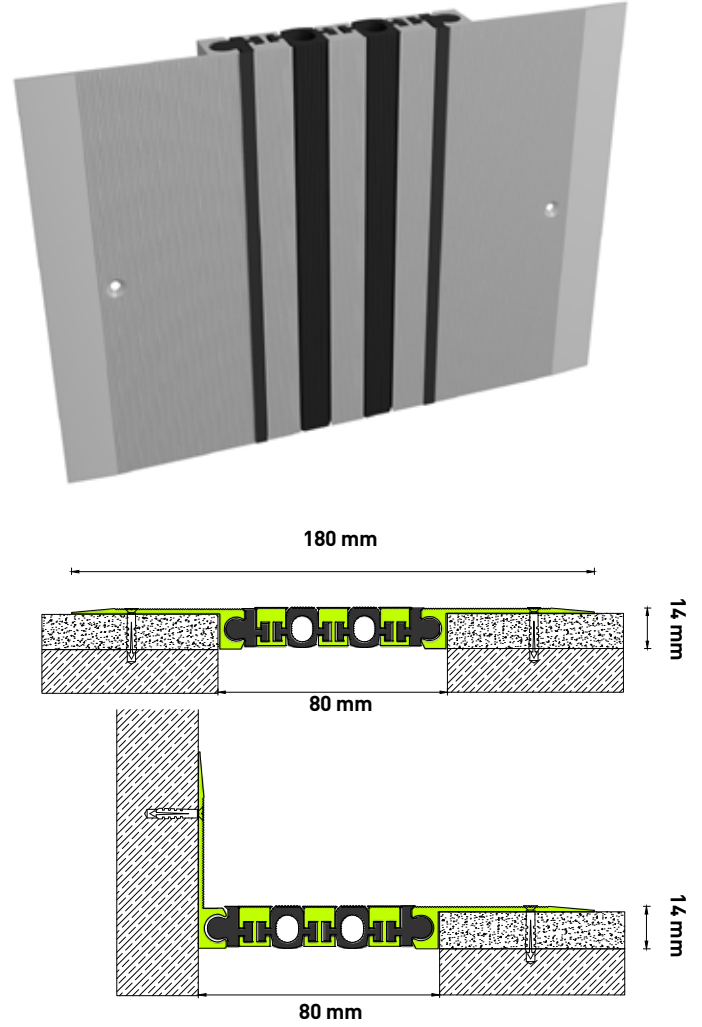

PROFİLLER 45 CM ARALIKLI HAVŞA BAŞ VİDA DELİKLİDİR, İSTEĞE BAĞLI ELOKSAL VEYA BOYA YAPILABİLİR.

DİLATASYON BOŞLUĞU	PROFİL YÜKSEKLİĞİ	HAREKET KAPASİTESİ	PROFİL GENİŞLİĞİ
80 mm	14 mm	± 12 mm	180 mm

100 mm KAPLAMA ALTI ZEMİN DİLATASYON PROFİLİ

ZKA 100-15

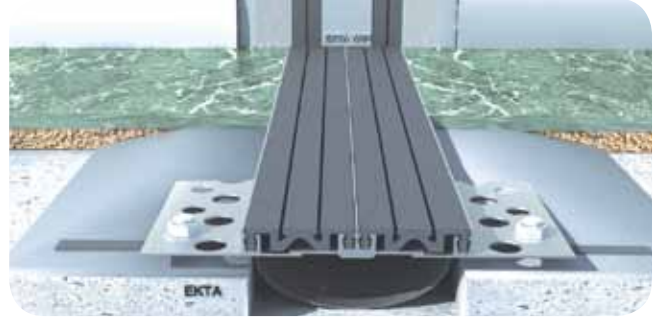
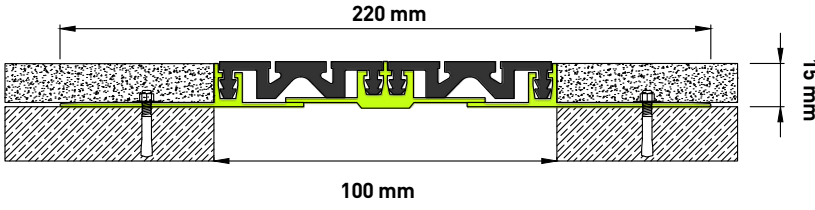
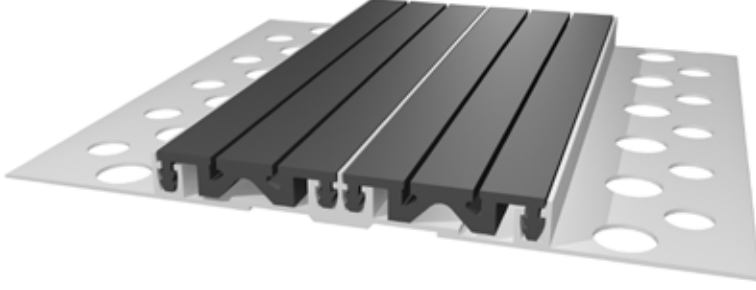

PROFİL NO	DİLATASYON BOŞLUĞU	PROFİL YÜKSEKLİĞİ	YÜK KAPASİTESİ	HAREKET KAPASİTESİ	PROFİL GENİŞLİĞİ
ZKA 100-15	100 mm	15 mm		± 20 mm	220 mm

100 mm KAPLAMA ALTI ZEMİN DİLATASYON PROFİLİ

ZKA 100-35

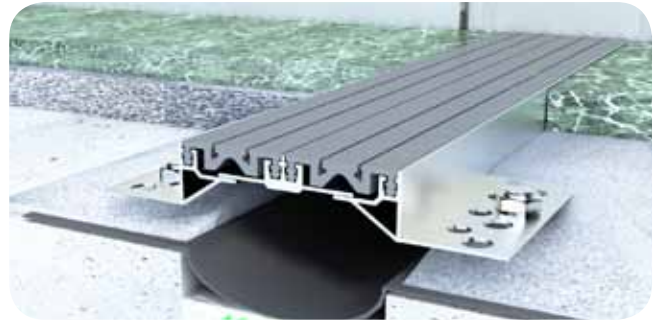
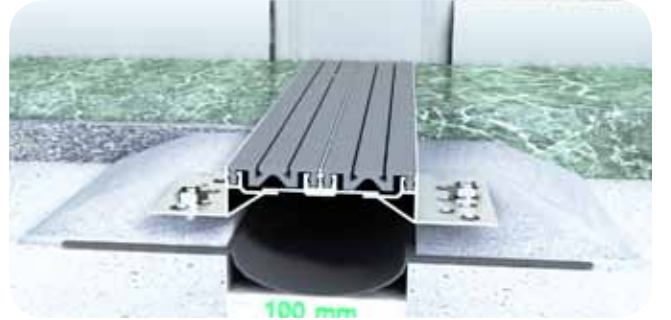
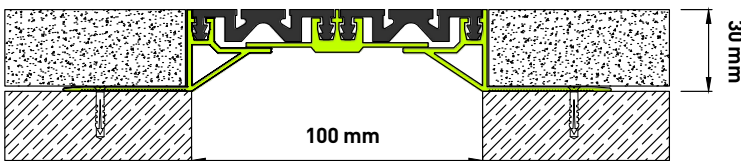
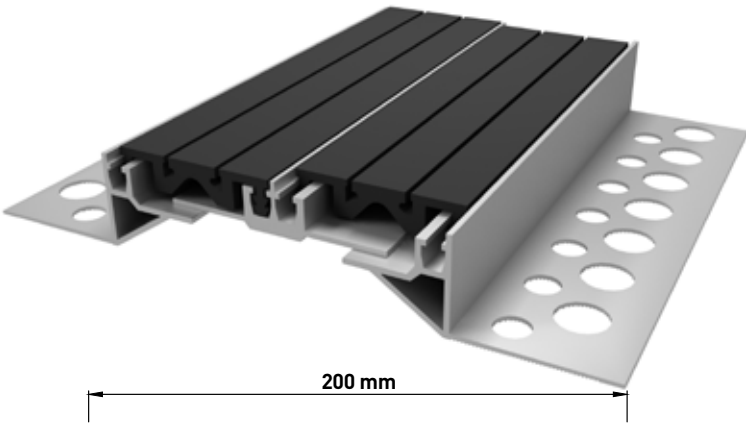

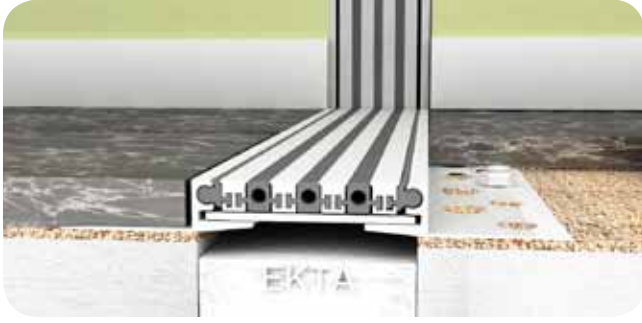
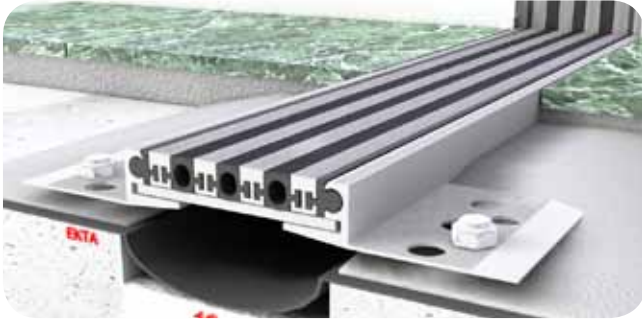

PROFİL NO	DİLATASYON BOŞLUĞU	PROFİL YÜKSEKLİĞİ	YÜK KAPASİTESİ	HAREKET KAPASİTESİ	PROFİL GENİŞLİĞİ
ZKA 100-30	100 mm	30 mm		± 20 mm	200 mm

100 mm KAPLAMA ALTI ZEMİN DİLATASYON PROFİLİ

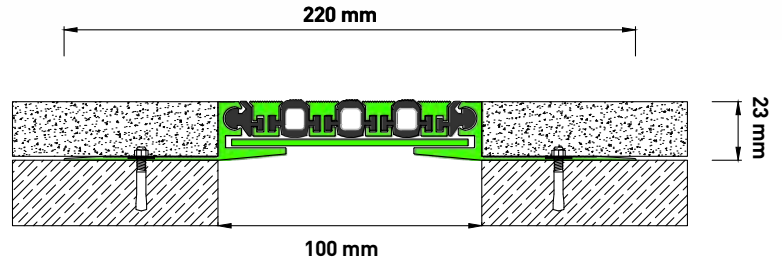

ZKA 100-23



PROFİL NO	DİLATASYON BOŞLUĞU	PROFİL YÜKSEKLİĞİ	YÜK KAPASİTESİ	HAREKET KAPASİTESİ	PROFİL GENİŞLİĞİ
ZKA 100-23	100 mm	23 mm		± 8 mm	220 mm

100 mm KAPLAMA ALTI ZEMİN DİLATASYON PROFİLİ

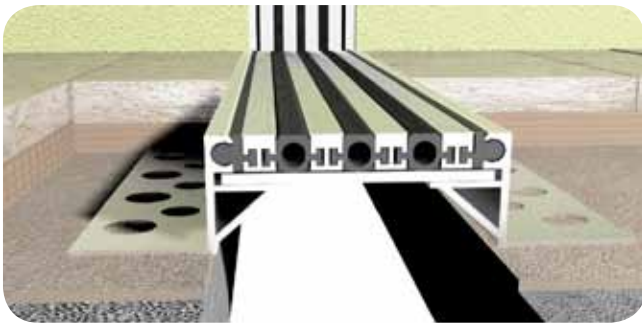
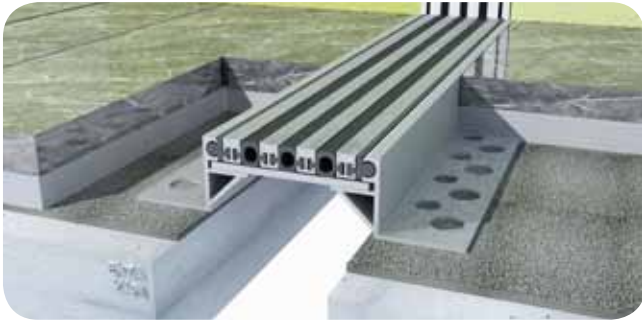

ZKA 100-43

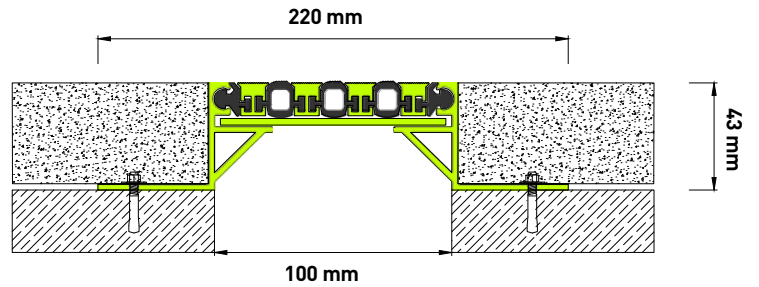

PROFİL NO	DİLATASYON BOŞLUĞU	PROFİL YÜKSEKLİĞİ	YÜK KAPASİTESİ	HAREKET KAPASİTESİ	PROFİL GENİŞLİĞİ
ZKA 100-43	100 mm	43 mm		± 8 mm	200 mm

100 mm KAPLAMA ALTI ZEMİN DİLATASYON PROFİLİ

ZKA 100-50

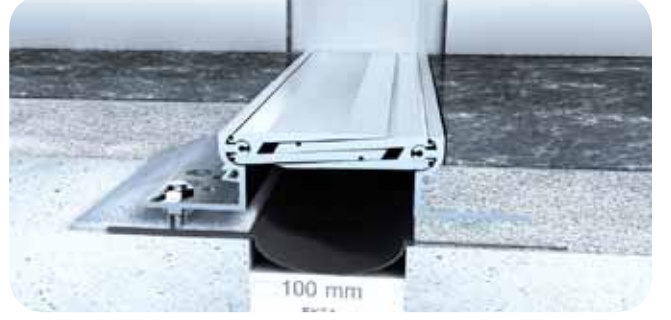
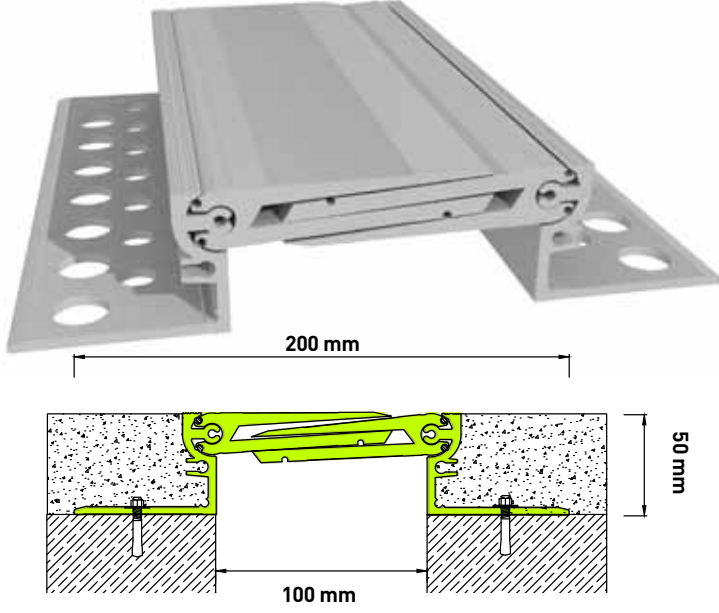

PROFİL NO	DİLATASYON BOŞLUĞU	PROFİL YÜKSEKLİĞİ	YÜK KAPASİTESİ	HAREKET KAPASİTESİ	PROFİL GENİŞLİĞİ
ZKA 100-50	100 mm	50 mm		± 25 mm	200 mm

SU YALITIMLI DİLATASYON PROFİLİ

ZKA 100-50/Y

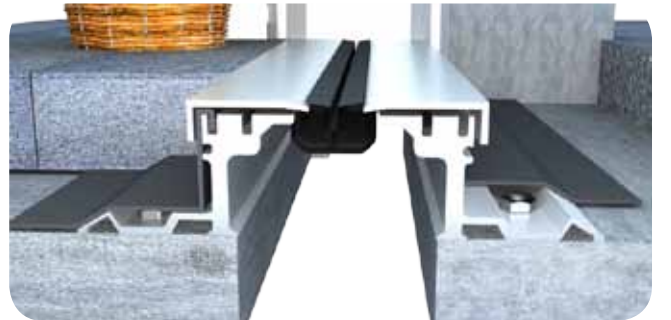
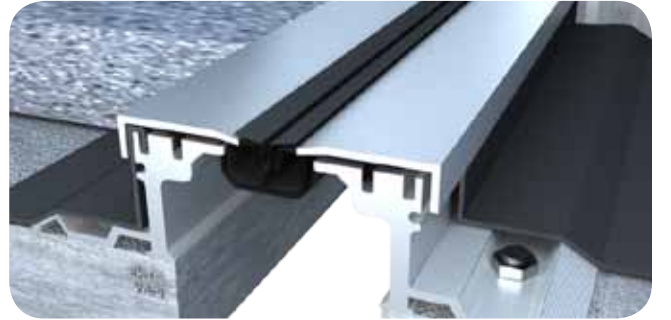
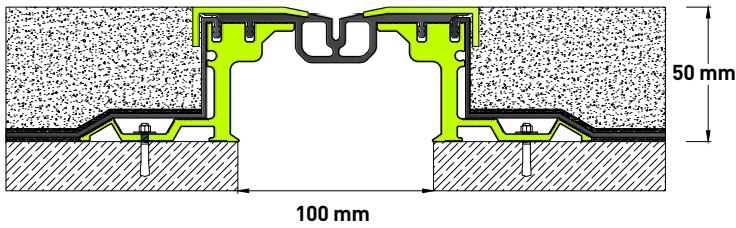
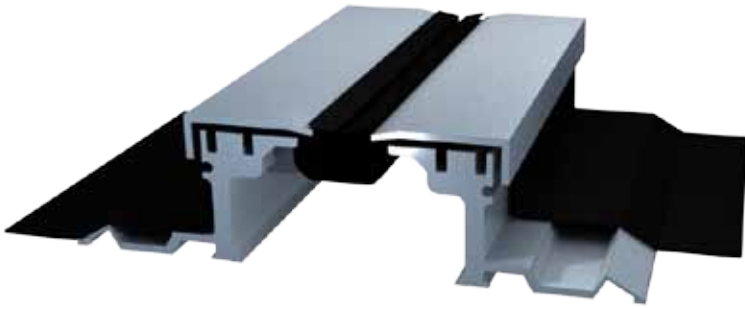

PROFİL NO	DİLATASYON BOŞLUĞU	PROFİL YÜKSEKLİĞİ	YÜK KAPASİTESİ	HAREKET KAPASİTESİ	PROFİL GENİŞLİĞİ
ZKA 100-50 / Y	100 mm	50 mm		± 14 mm	240 mm

100 mm KAPLAMA ÜZERİ ZEMİN DİLATASYON PROFİLİ



ZKU 100-30

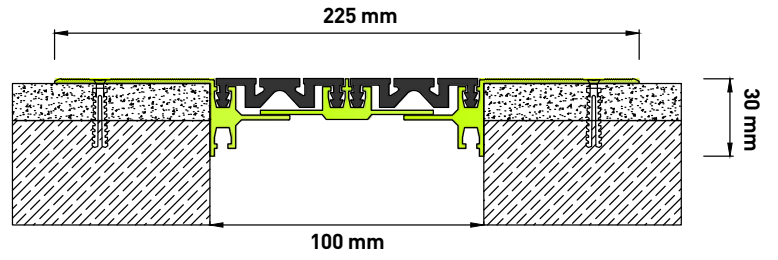
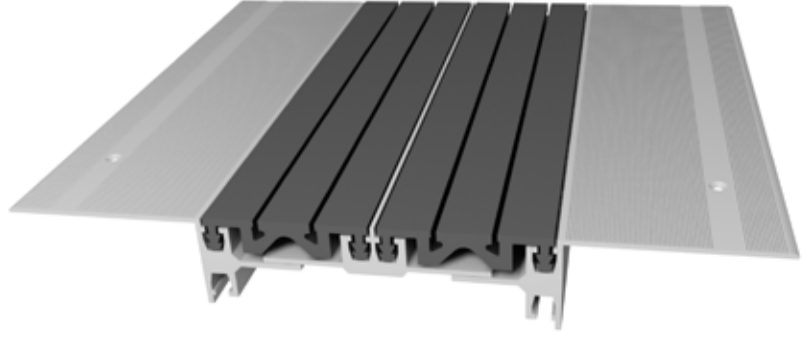

PROFİL NO	DİLATASYON BOŞLUĞU	PROFİL YÜKSEKLİĞİ	YÜK KAPASİTESİ	HAREKET KAPASİTESİ	PROFİL GENİŞLİĞİ
ZKU 100-30	100 mm	30 mm		± 20 mm	225 mm

100 mm KAPLAMA ÜZERİ ZEMİN DİLATASYON PROFİLİ

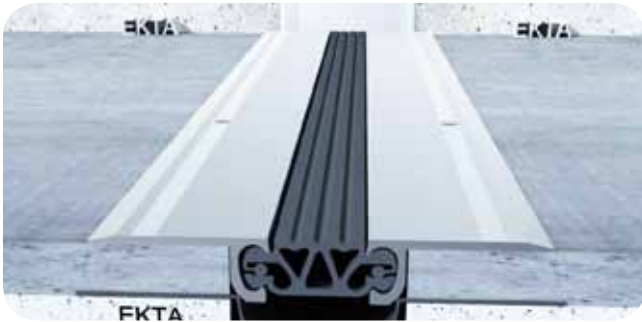

ZKU 100-35

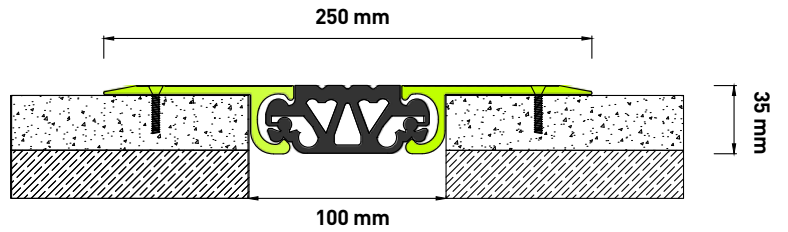
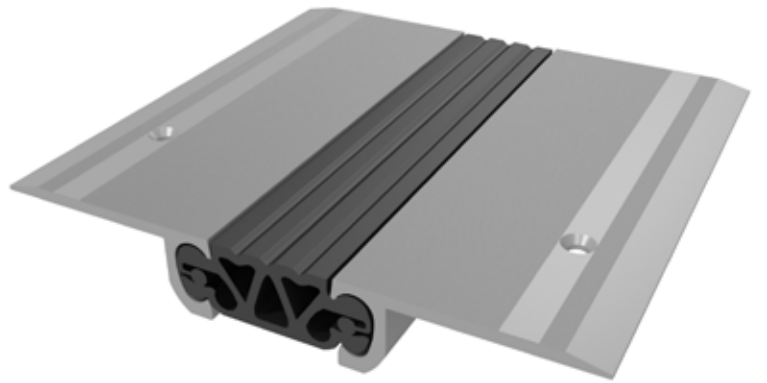

PROFİL NO	DİLATASYON BOŞLUĞU	PROFİL YÜKSEKLİĞİ	YÜK KAPASİTESİ	HAREKET KAPASİTESİ	PROFİL GENİŞLİĞİ
ZKU 100-35	100 mm	35 mm		± 20 mm	250 mm

100 mm KAPLAMA ÜZERİ ZEMİN DİLATASYON PROFİLİ

ZKU 100-40

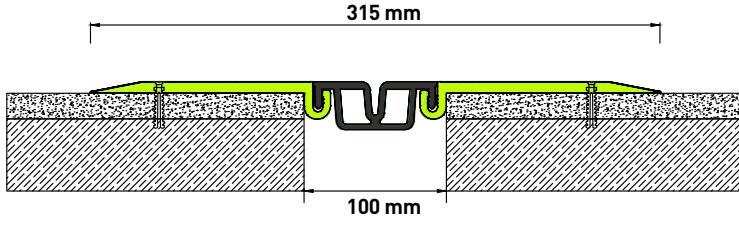
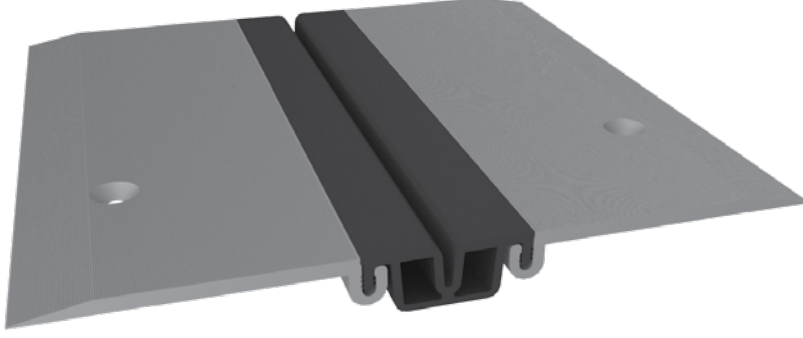

PROFİL NO	DİLATASYON BOŞLUĞU	PROFİL YÜKSEKLİĞİ	YÜK KAPASİTESİ	HAREKET KAPASİTESİ	PROFİL GENİŞLİĞİ
ZKU 100-40	100 mm	40 mm		± 30 mm	315 mm

100 mm KAPLAMA ÜZERİ ZEMİN DİLATASYON PROFİLİ

ZKU 100-43

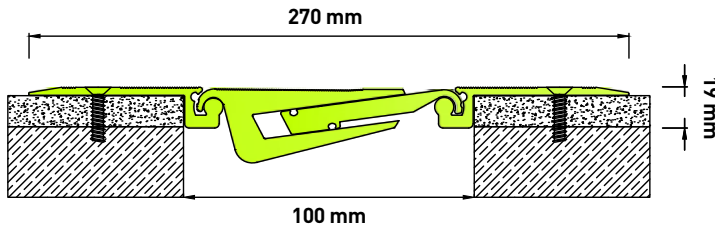

PROFİL NO	DİLATASYON BOŞLUĞU	PROFİL YÜKSEKLİĞİ	YÜK KAPASİTESİ	HAREKET KAPASİTESİ	PROFİL GENİŞLİĞİ
ZKU 100-43	100 mm	19 mm		± 20 mm	270 mm



DKU 100-14

DKU 100-19

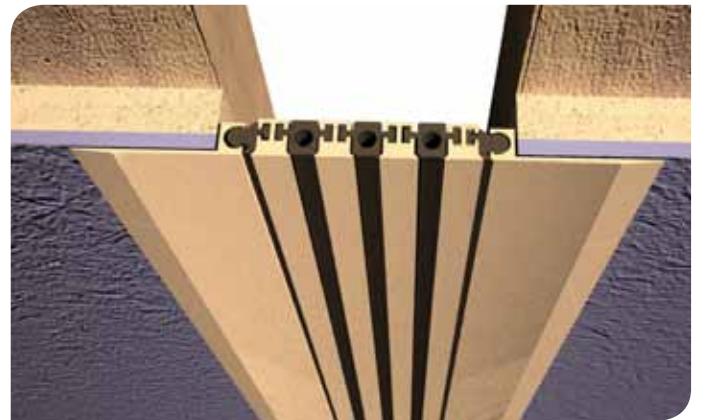
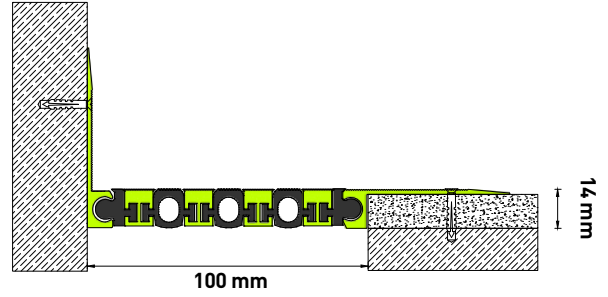
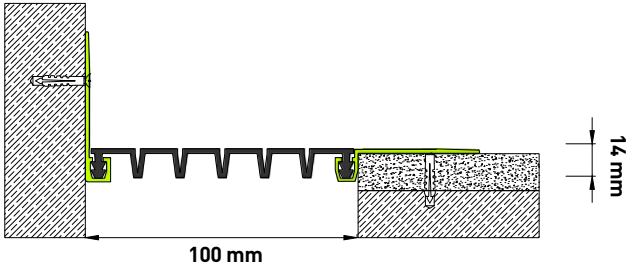
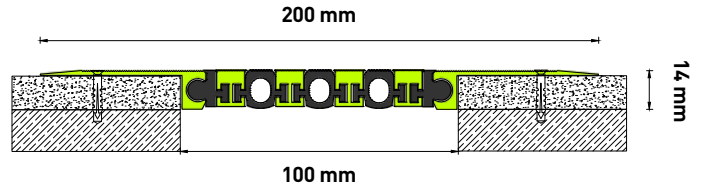
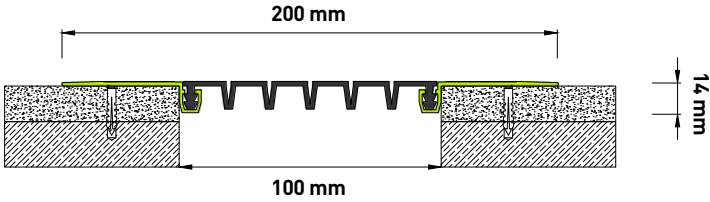
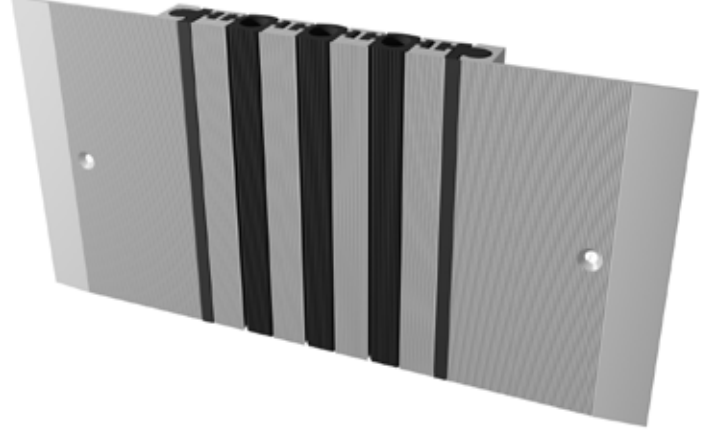

DİLASYON BOŞLUĞU	PROFİL YÜKSEKLİĞİ	HAREKET KAPASİTESİ	PROFİL GENİŞLİĞİ
100 mm	14 mm	± 40 mm	200 mm

DİLASYON BOŞLUĞU	PROFİL YÜKSEKLİĞİ	HAREKET KAPASİTESİ	PROFİL GENİŞLİĞİ
100 mm	14 mm	± 8 mm	200 mm

PROFİLLER 45 CM ARALIKLI HAVŞA BAŞ VİDA DELİKLİDİR, İSTEĞE BAĞLI ELOKSAL VEYA BOYA YAPILABİLİR.

PROFİLLER 45 CM ARALIKLI HAVŞA BAŞ VİDA DELİKLİDİR, İSTEĞE BAĞLI ELOKSAL VEYA BOYA YAPILABİLİR.

DKA 100-14

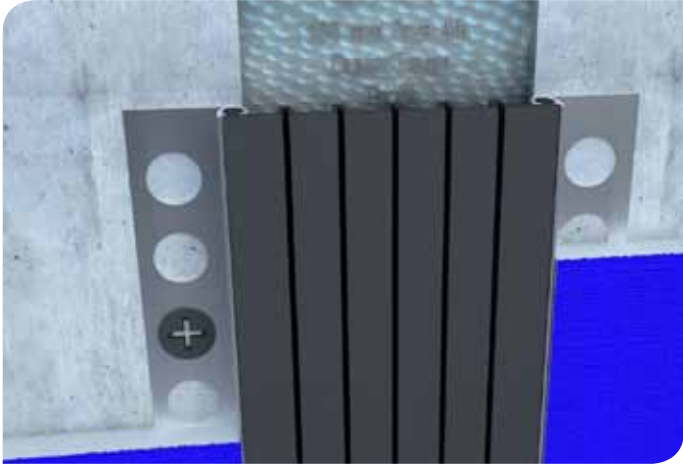
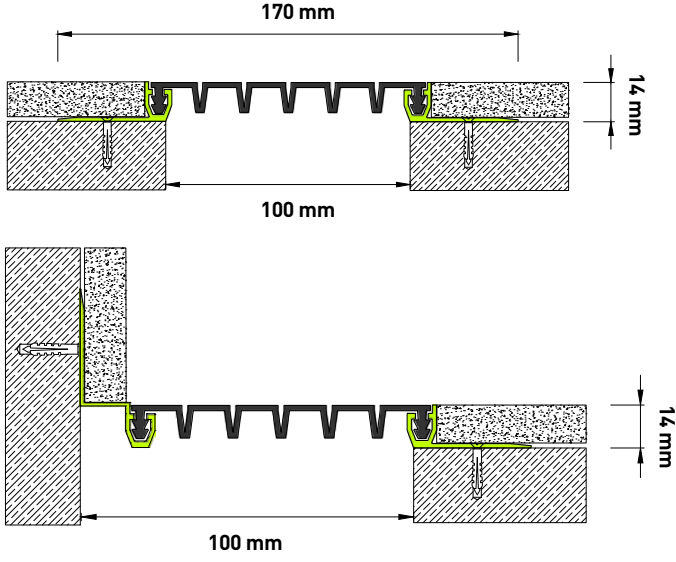

DİLATASYON BOŞLUĞU	PROFİL YÜKSEKLİĞİ	HAREKET KAPASİTESİ	PROFİL GENİŞLİĞİ
100 mm	14 mm	± 20 mm	170 mm

DKA 100-19

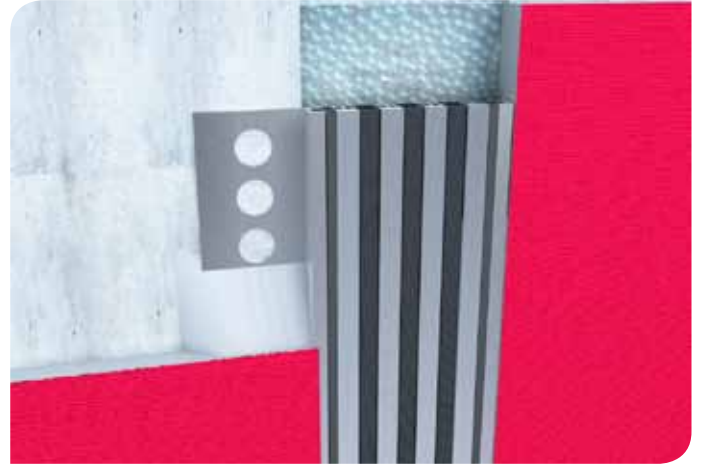
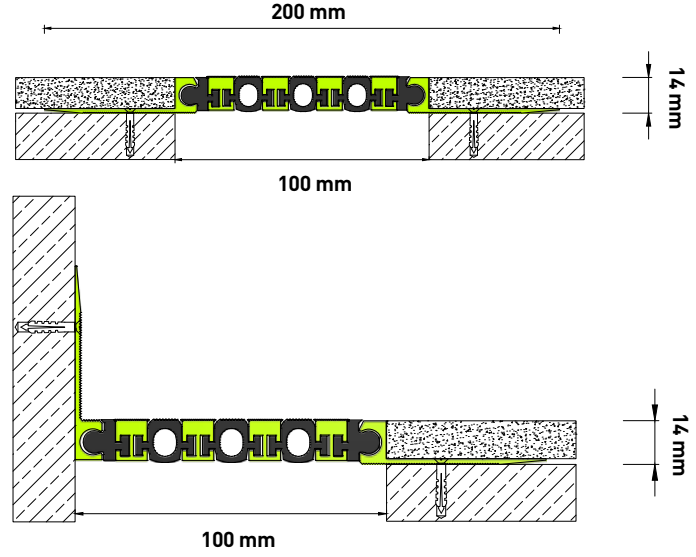
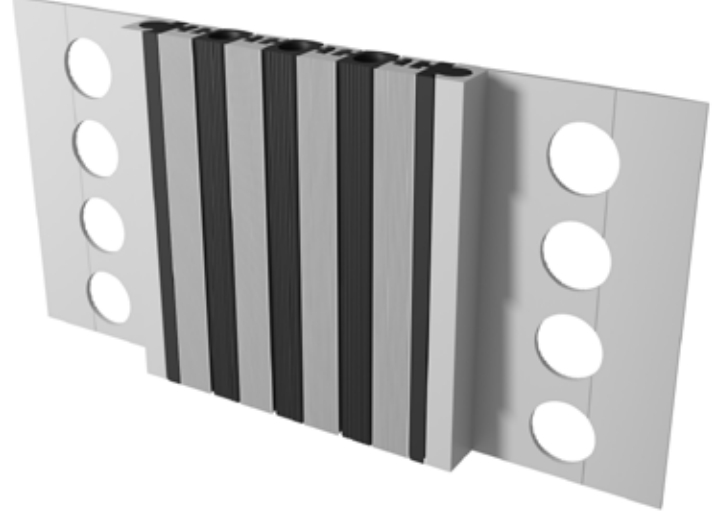

DİLATASYON BOŞLUĞU	PROFİL YÜKSEKLİĞİ	HAREKET KAPASİTESİ	PROFİL GENİŞLİĞİ
50 mm	14 mm	± 12 mm	200 mm

140 mm KAPLAMA ALTI ZEMİN DİLATASYON PROFİLİ

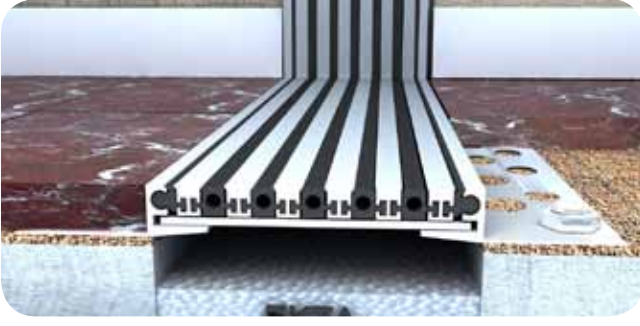

ZKA 140-23

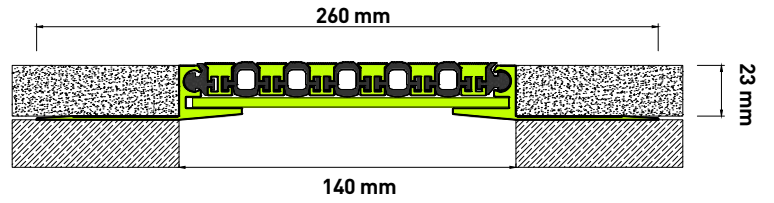

PROFİL NO	DİLATASYON BOŞLUĞU	PROFİL YÜKSEKLİĞİ	YÜK KAPASİTESİ	HAREKET KAPASİTESİ	PROFİL GENİŞLİĞİ
ZKA 140-23	140 mm	23 mm		± 12 mm	260 mm

140 mm KAPLAMA ALTI ZEMİN DİLATASYON PROFİLİ



ZKA 140-43

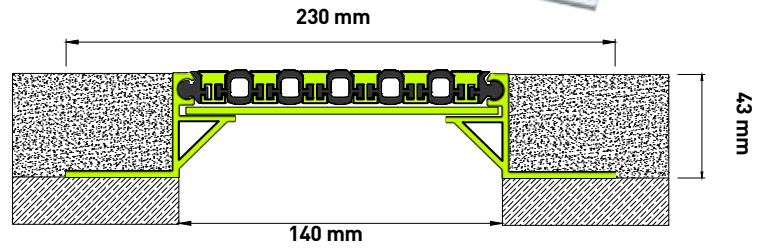

PROFİL NO	DİLATASYON BOŞLUĞU	PROFİL YÜKSEKLİĞİ	YÜK KAPASİTESİ	HAREKET KAPASİTESİ	PROFİL GENİŞLİĞİ
ZKA 140-43	200 mm	43 mm		± 12 mm	230 mm

200 mm KAPLAMA ALTI ZEMİN DİLATASYON PROFİLİ

ZKA 200-23

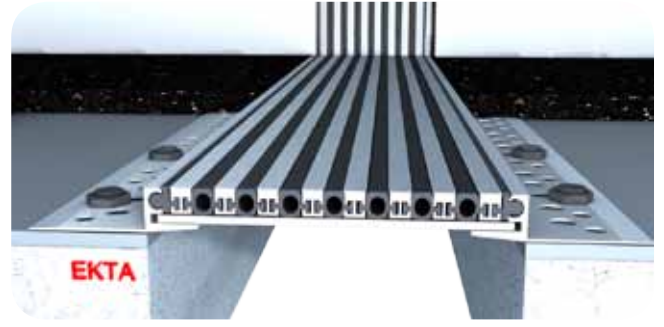
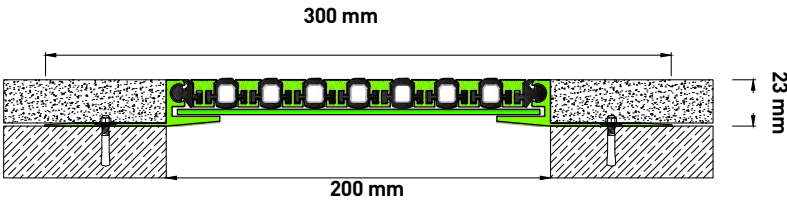

PROFİL NO	DİLATASYON BOŞLUĞU	PROFİL YÜKSEKLİĞİ	YÜK KAPASİTESİ	HAREKET KAPASİTESİ	PROFİL GENİŞLİĞİ
ZKA 200-23	200 mm	23 mm		± 16 mm	300 mm

200 mm KAPLAMA ALTI ZEMİN DİLATASYON PROFİLİ

ZKA 200-43

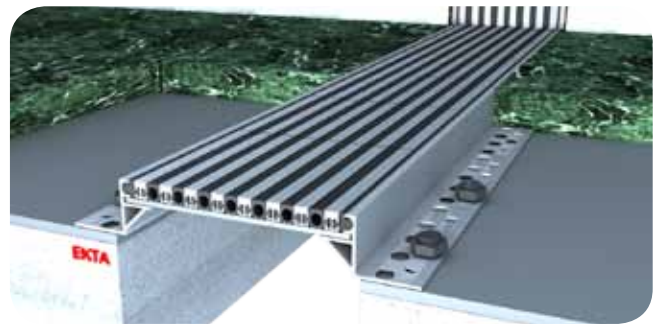
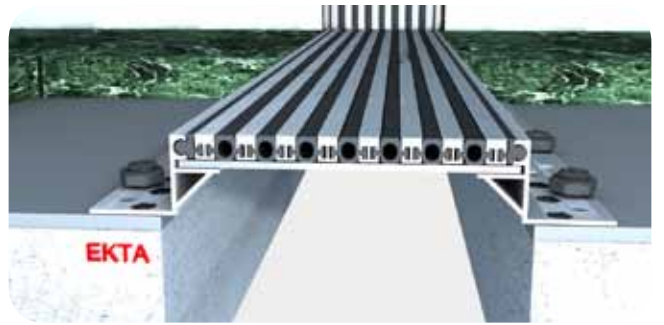
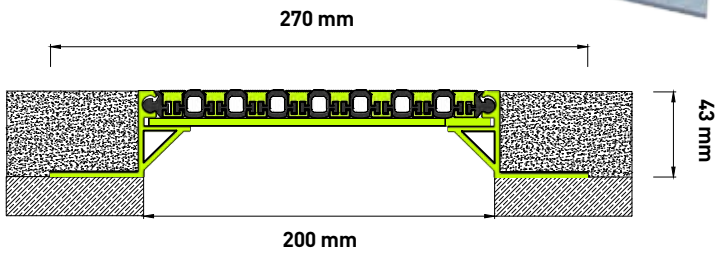

PROFİL NO	DİLATASYON BOŞLUĞU	PROFİL YÜKSEKLİĞİ	YÜK KAPASİTESİ	HAREKET KAPASİTESİ	PROFİL GENİŞLİĞİ
ZKA 200-43	200 mm	43 mm		± 16 mm	270 mm



DKA 100-20

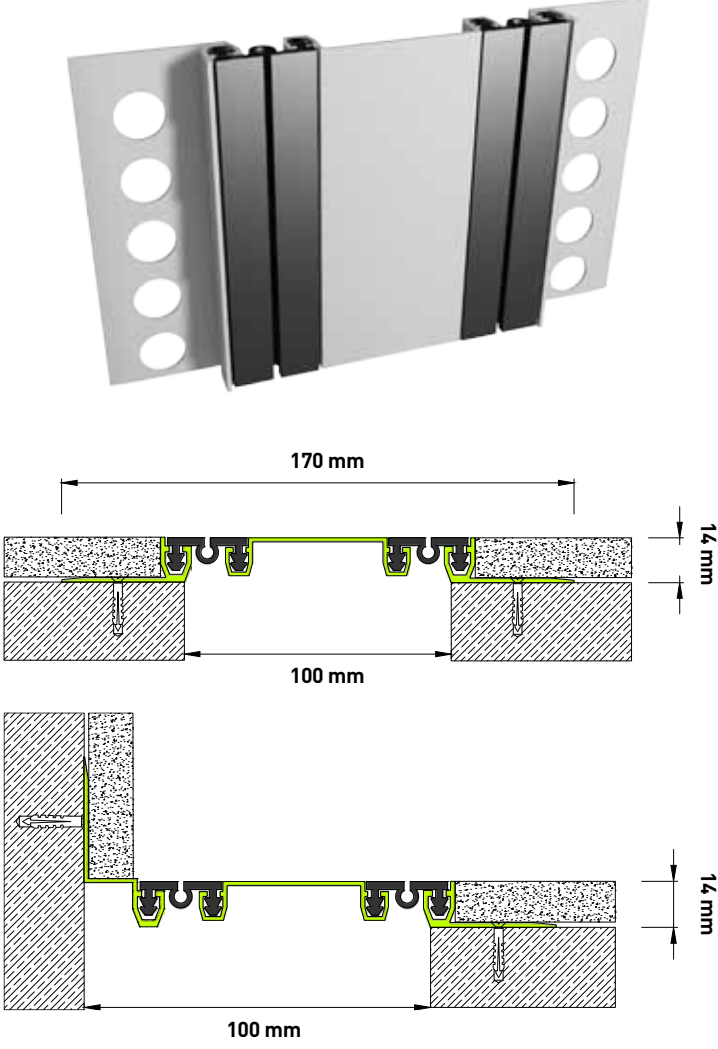

DİLATASYON BOŞLUĞU	PROFİL YÜKSEKLİĞİ	HAREKET KAPASİTESİ	PROFİL GENİŞLİĞİ
100 mm	14 mm	± 18 mm	170 mm

DKA 150-20

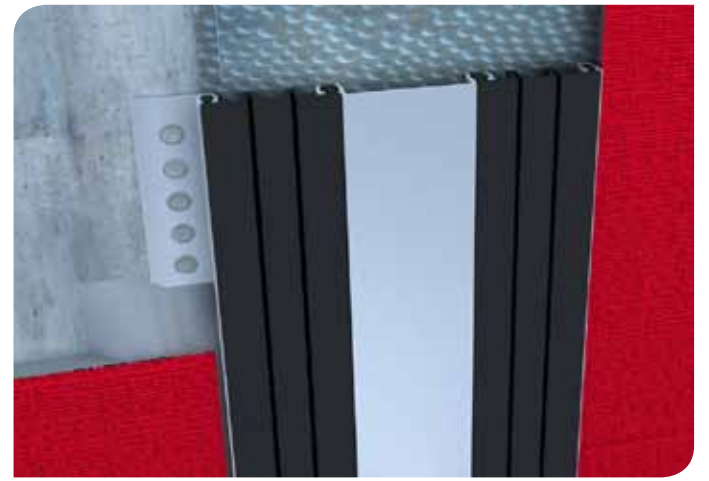
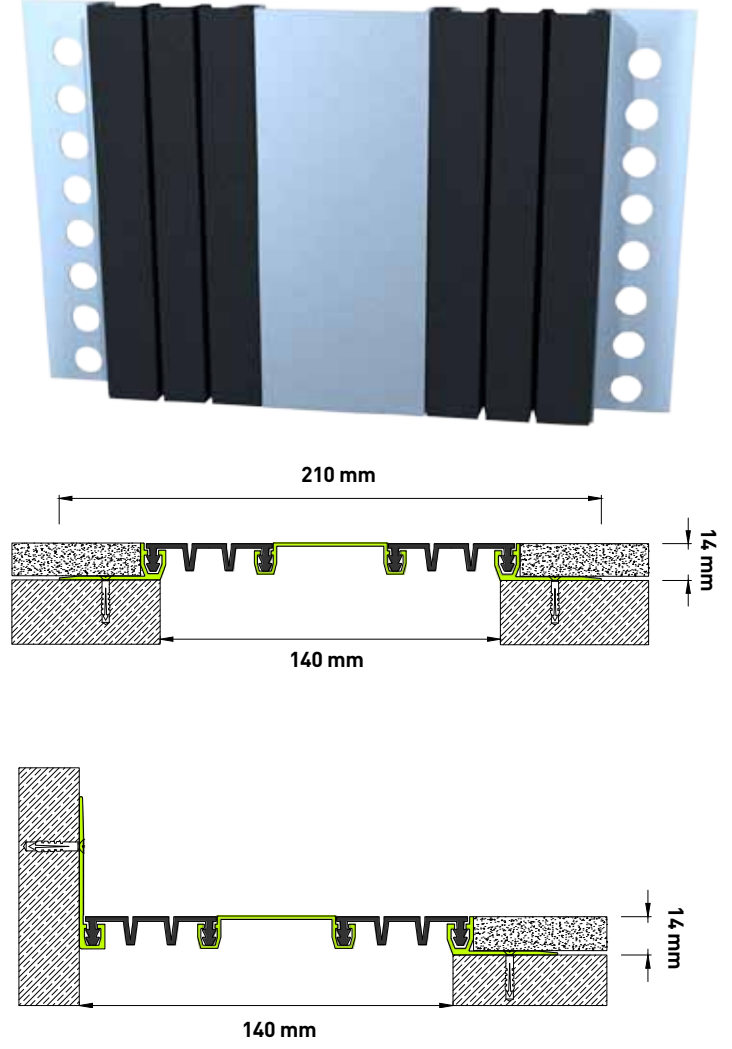

DİLATASYON BOŞLUĞU	PROFİL YÜKSEKLİĞİ	HAREKET KAPASİTESİ	PROFİL GENİŞLİĞİ
140 mm	14 mm	± 20 mm	210 mm

100 mm KAPLAMA ÜZERİ DUVAR TAVAN PROFİLİ

DKU 100-20

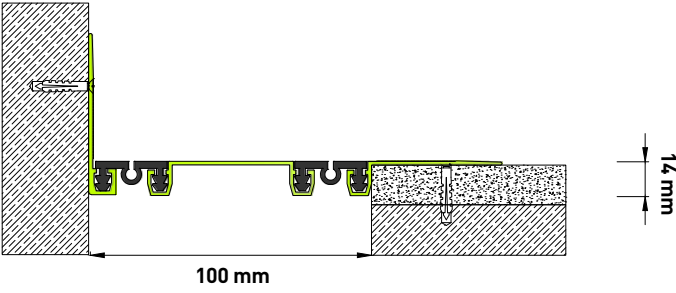
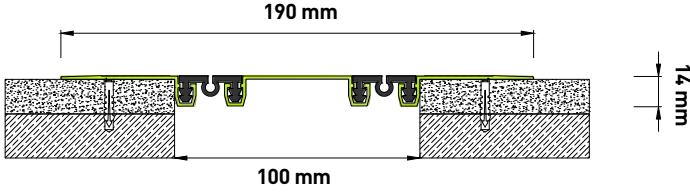
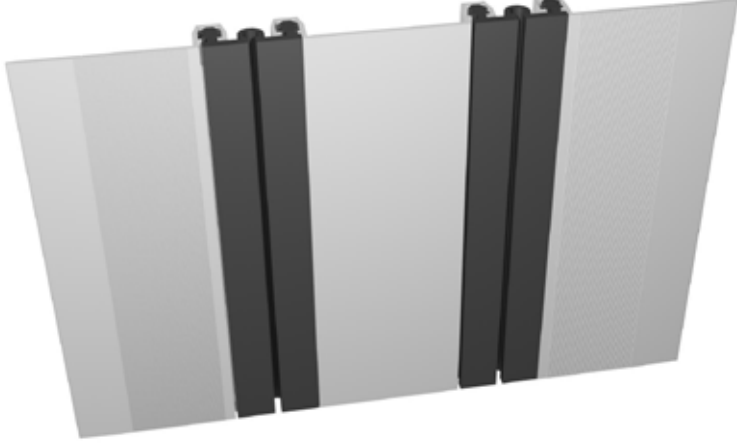

DİLATASYON BOŞLUĞU	PROFİL YÜKSEKLİĞİ	HAREKET KAPASİTESİ	PROFİL GENİŞLİĞİ
100 mm	14 mm	± 18 mm	190 mm

PROFİLLER 45 CM ARALIKLI HAVŞA BAŞ VİDA DELİKLİDİR, İSTEĞE BAĞLI ELOKSAL VEYA BOYA YAPILABİLİR.

DKU 140-20

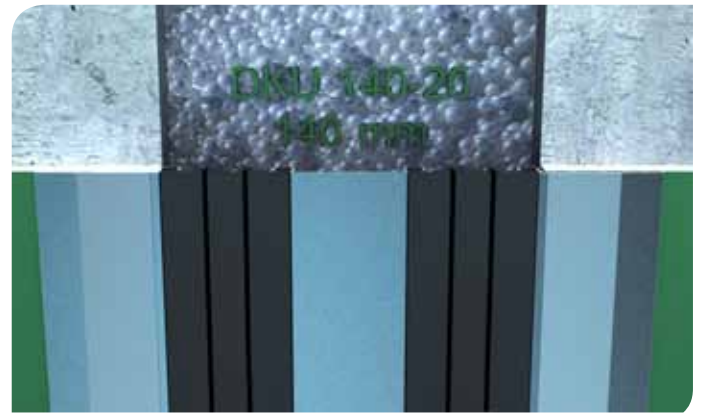
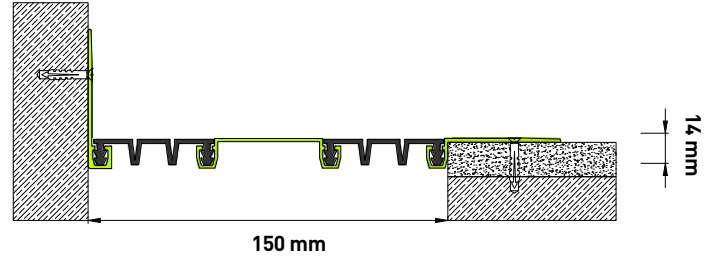
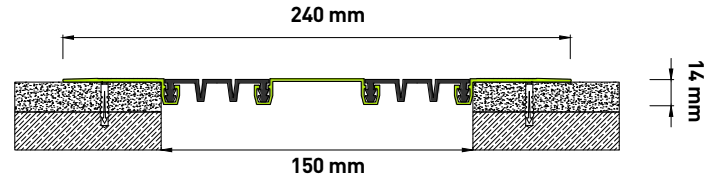

DİLATASYON BOŞLUĞU	PROFİL YÜKSEKLİĞİ	HAREKET KAPASİTESİ	PROFİL GENİŞLİĞİ
140 mm	14 mm	± 30 mm	240 mm

PROFİLLER 45 CM ARALIKLI HAVŞA BAŞ VİDA DELİKLİDİR, İSTEĞE BAĞLI ELOKSAL VEYA BOYA YAPILABİLİR.



ZK 120

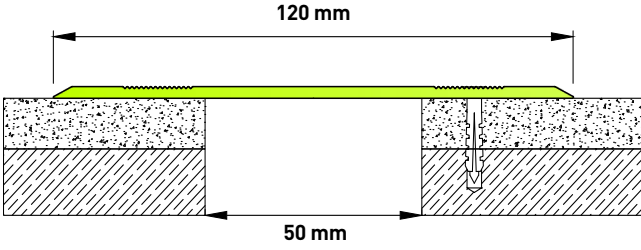
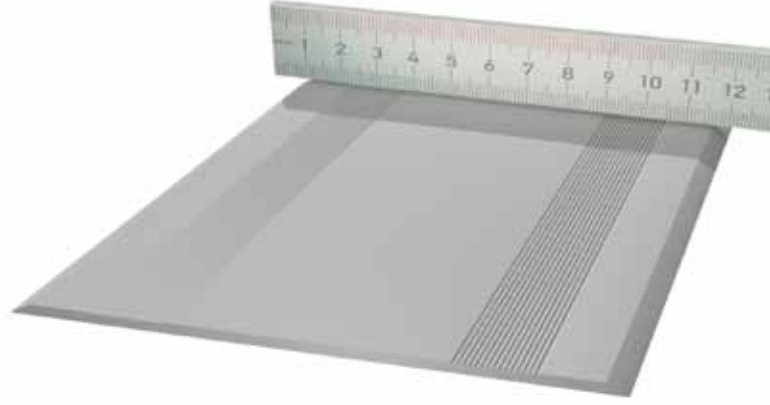

120 mm Gümüş Eloksalli Zemin Kapak Dilatasyon Profili, tek taraftan 45 cm aralıklı havşa baş vida delikli sevk edilir.

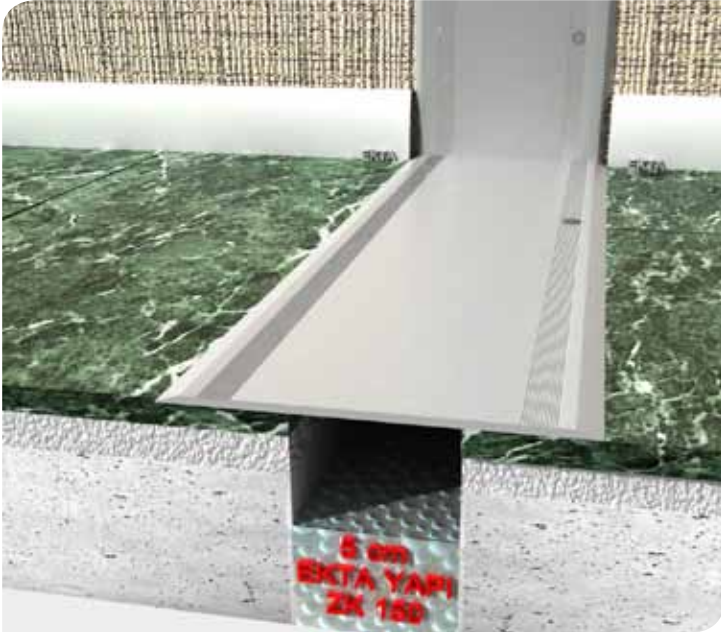

ZK 150

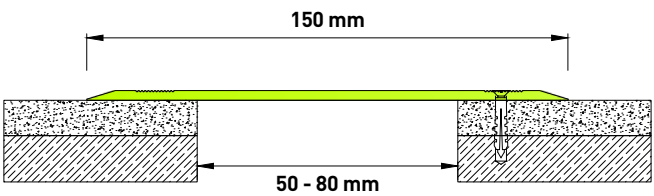
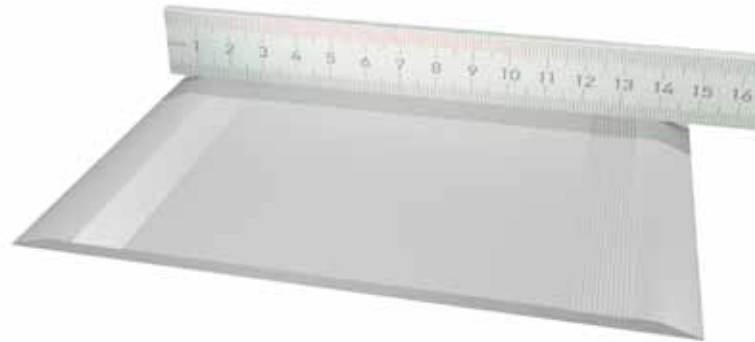

150 mm Gümüş Eloksalli Zemin Kapak Dilatasyon Profili, tek taraftan 45 cm aralıklı havşa baş vida delikli sevk edilir.

ZEMİN KAPAK PROFİLLERİ



ZK 200

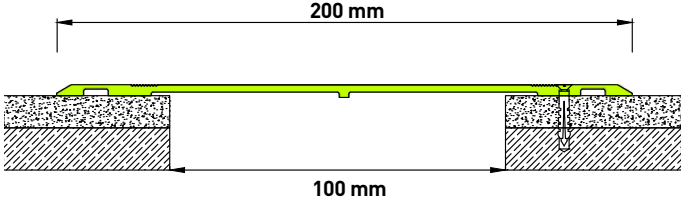

200 mm Gümüş Eloksalli Zemin Kapak Dilatasyon Profili, tek taraftan 45 cm aralıklı havşa baş vida delikli sevk edilir.

KZK SERİSİ

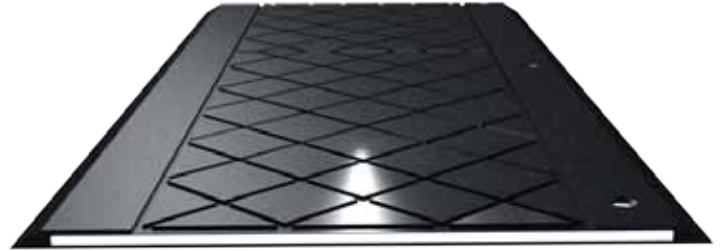

PROFİL KODU	DİLATASYON BOŞLUĞU	GENİŞLİK
KZK 200	50 mm	200 mm
KZK 250	100 mm	250 mm
KZK 300	150 mm	300 mm
KZK 350	200 mm	350 mm

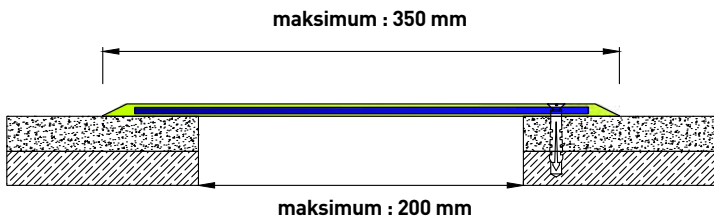

Ağır yük geçişine uygun kauçuk kaplı çelik zemin dilatasyon profili.



DK 100

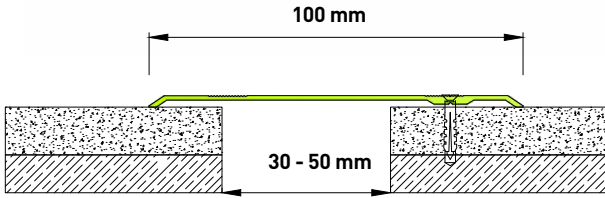

100 mm Gümüş Eloksalli Duvar Tavan Kapak Dilatasyon Profili, Tek Taraftan 45 cm aralıklı havşa baş vida delikli sevk edilir.

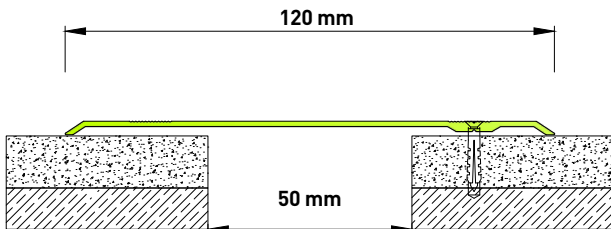

DK 120



120 mm Gümüş Eloksalli Duvar Tavan Kapak Dilatasyon Profili, Tek Taraftan 45 cm aralıklı havşa baş vida delikli sevk edilir.

DUVAR TAVAN KAPAK PROFİLLERİ

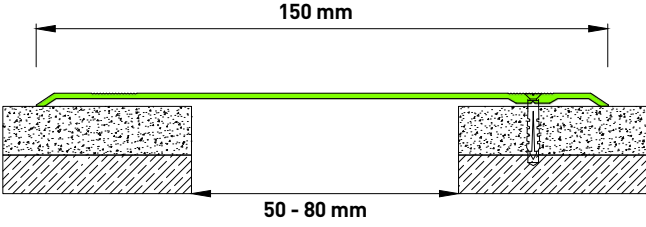

DK 150



150 mm Gümüş Eloksalli Duvar Tavan Kapak Dilatasyon Profili, Tek Taraftan 45 cm aralıklı havşa baş vida delikli sevk edilir.

DK 200

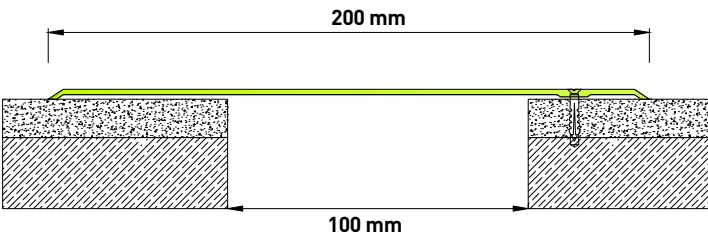

200 mm Gümüş Eloksalli Duvar Tavan Kapak Dilatasyon Profili, Tek Taraftan 45 cm aralıklı havşa baş vida delikli sevk edilir.



DK 5080

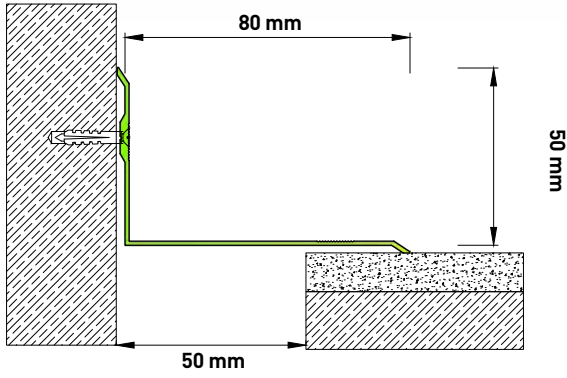

DK 50100

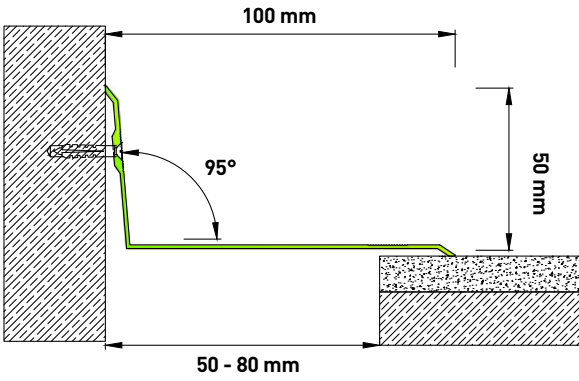

Gümüş Eloksalli Duvar Tavan Köşe Kapak Dilatasyon Profilleri, tek taraftan 45 cm aralıklı havşa baş vida delikli sevk edilir.

KÖŞE KAPAK PROFİLLERİ

DK 50150

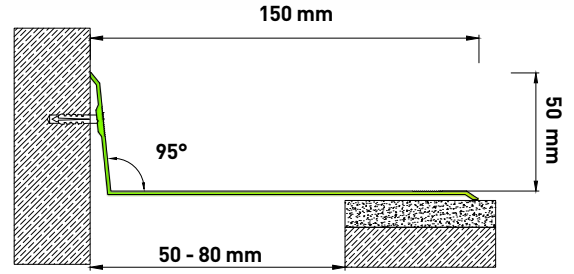

DPA 60

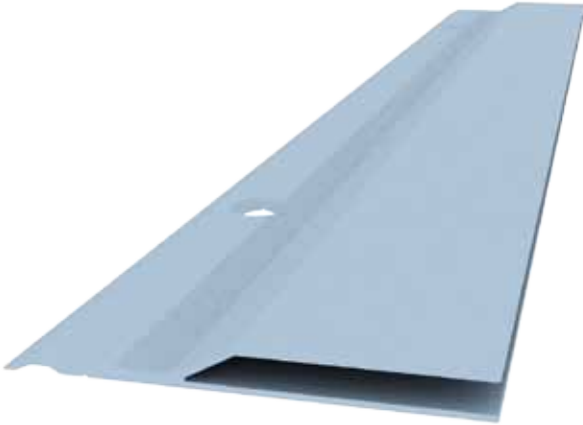

60 mm Gümüş Eloksalli Duvar Tavan Kapak Dilatasyon Aparatı. Bütün kapak profilleri ile uyumludur, tek taraftan 45 cm aralıklı havşa baş vida delikli sevk edilir.

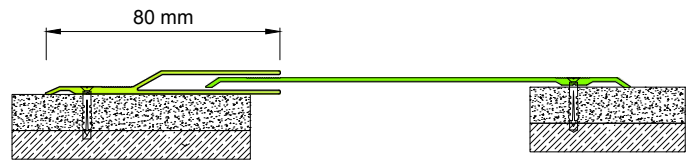

ZEMİN KAPLAMA ALTI ZEMİN DİLATASYON
PROFİLLERİ KÖŞE DETAYLARI



ZKA 30-14/K

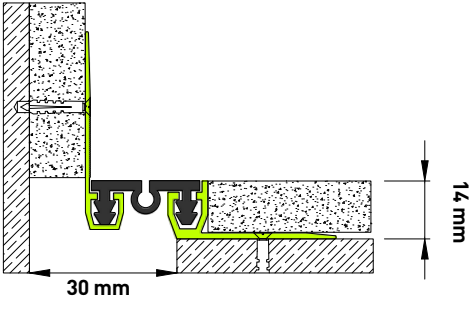

ZKA 60-43/K

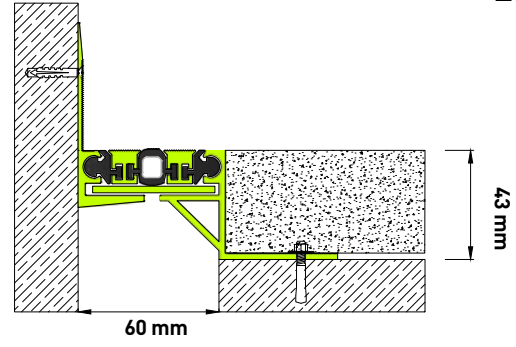

ZKA 30-19/K

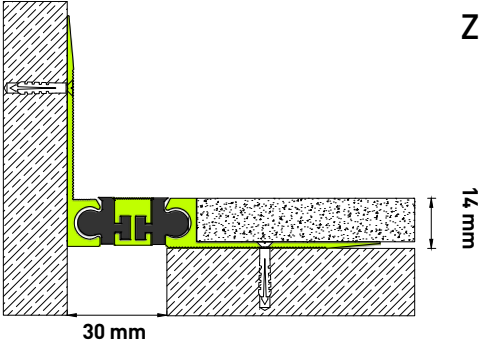

ZKA 80-30/K

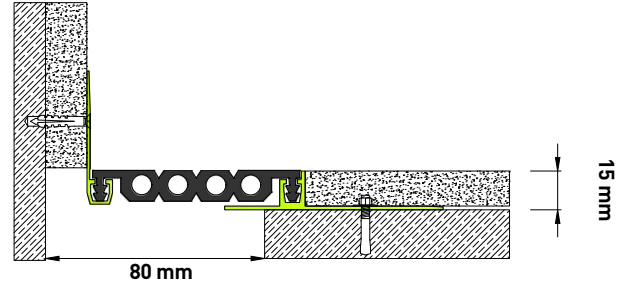

ZKA 50-35/K

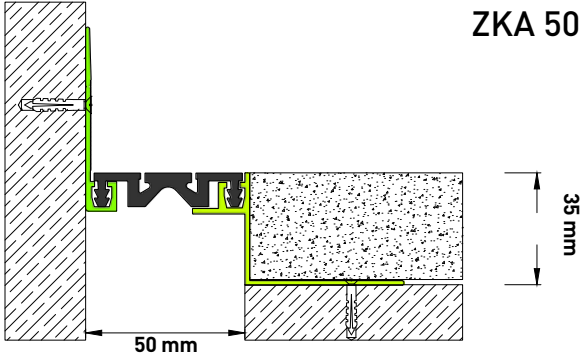

ZKA 100-30/K

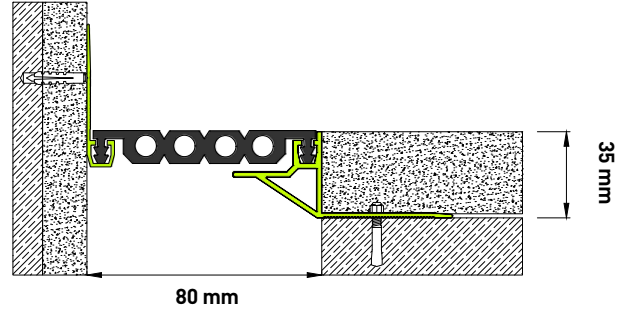

ZKA 50-50/K

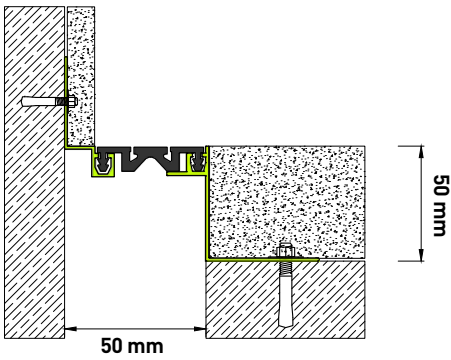

ZKA 100-15/K

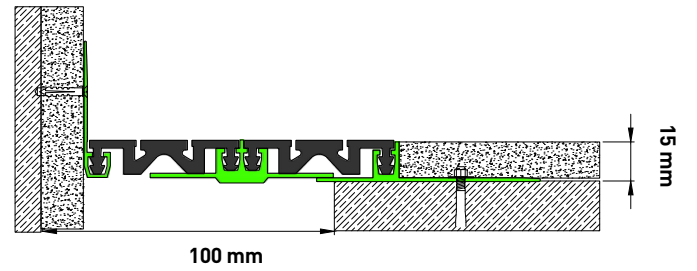

ZKA 60-43/K

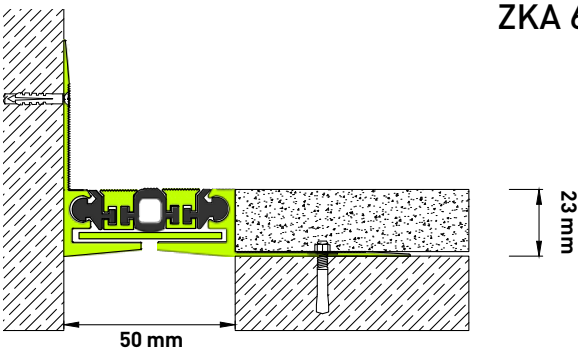

ZKA100-23/K

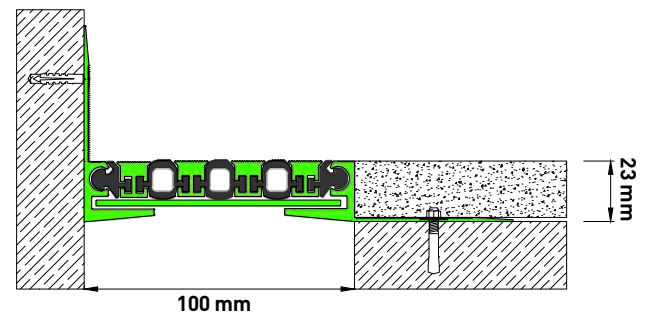

KAPLAMA ÜZERİ ZEMİN DİLATASYON PROFİLLERİ KÖŞE DETAYLARI

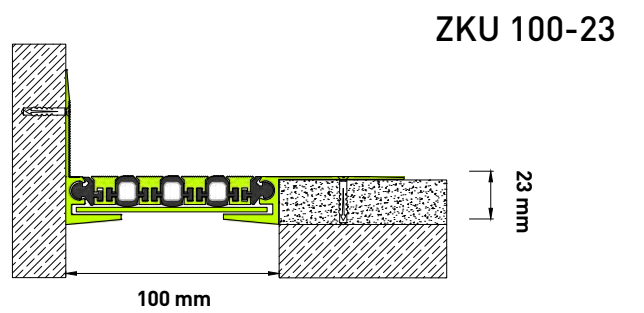
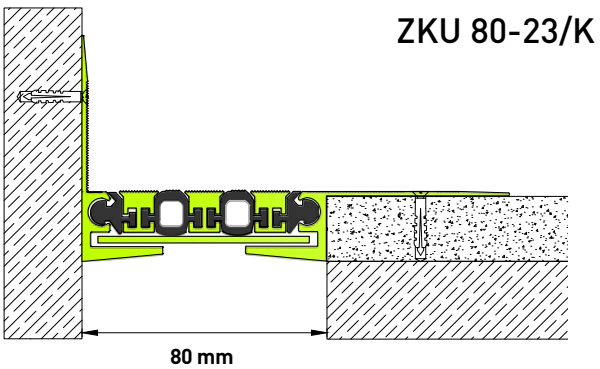
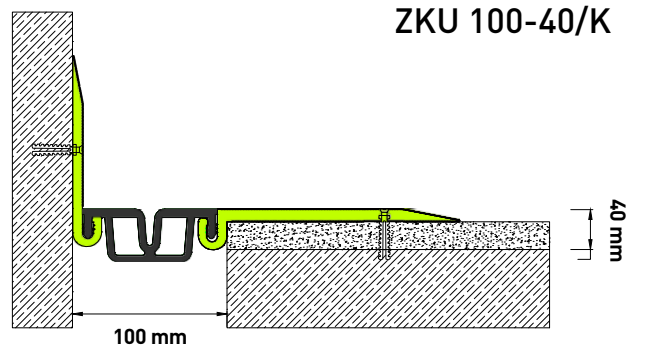
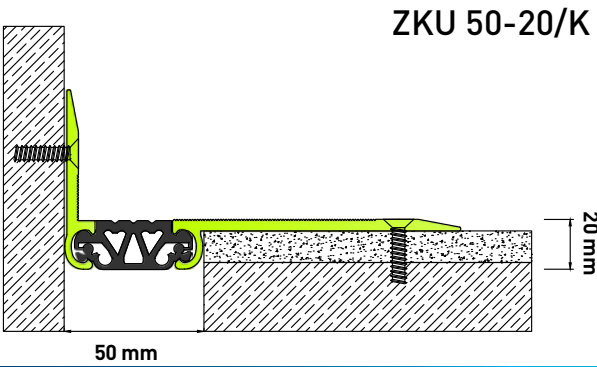
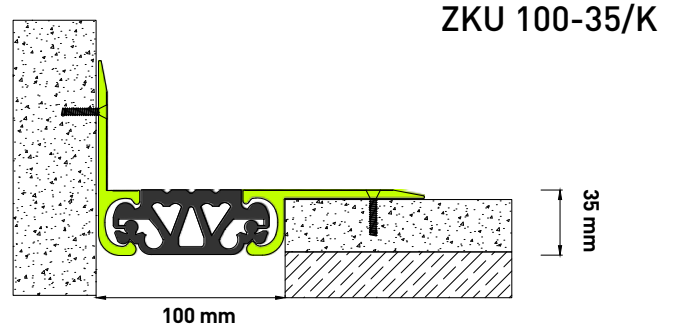
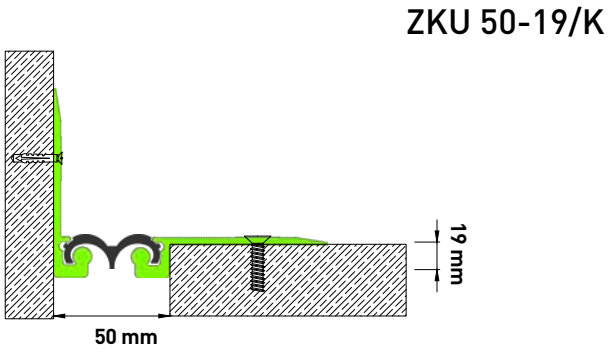
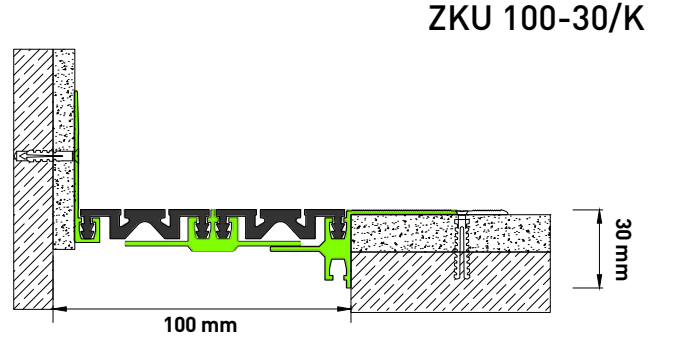
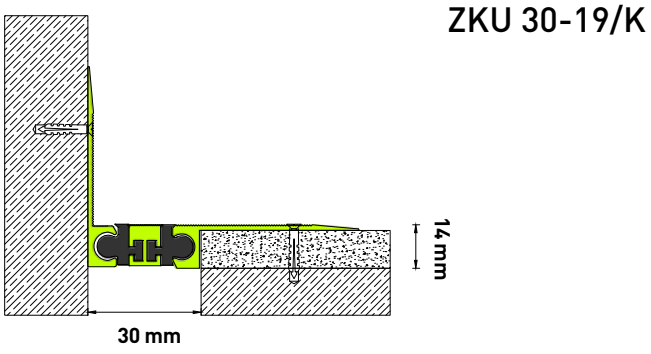
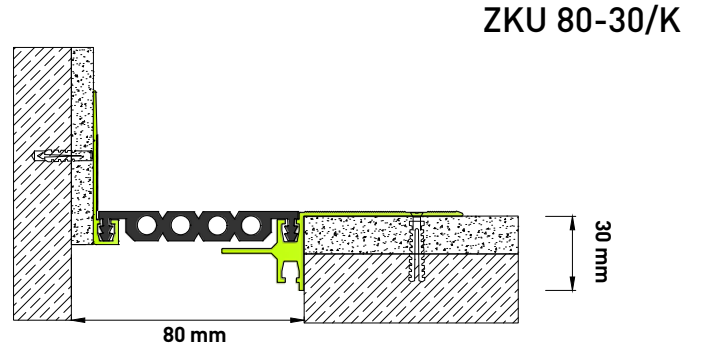
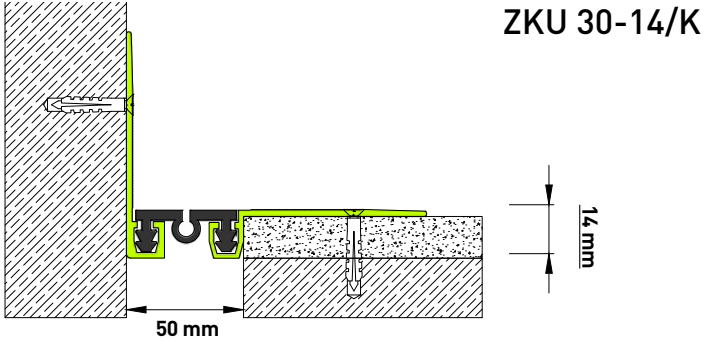

SÜPÜRGELİK PROFİLLERİ



Ürün Kodu	SP 60LM
Açıklama	60 mm Alüminyum Süpürgelik Profili
Boy	3,00 mt
Renkler	Mat Eloksal Elektrostatik Boya

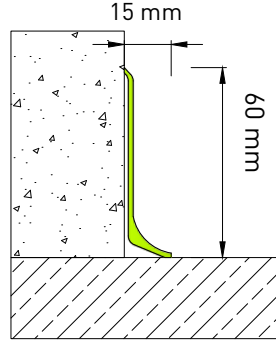

Ürün Kodu	SP 60
Açıklama	60 mm Alüminyum Süpürgelik Profili
Boy	3,00 mt
Renkler	Mat Eloksal Elektrostatik Boya

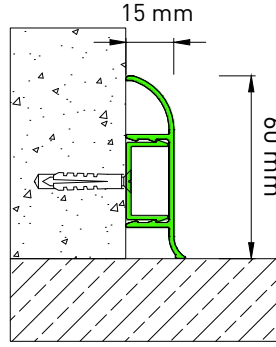

Ürün Kodu	SP 85
Açıklama	85 mm Alüminyum Süpürgelik Profili
Boy	3,00 mt
Renkler	Mat Eloksal Elektrostatik Boya

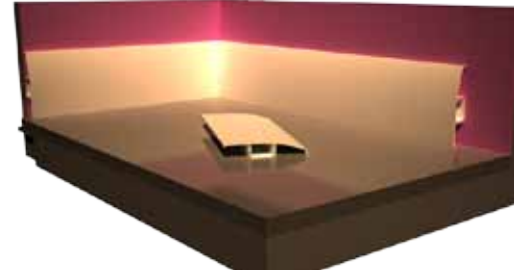
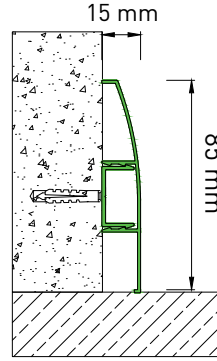

Ürün Kodu	SP 100
Açıklama	100 mm Alüminyum Süpürgelik Profili
Boy	3,00 mt
Renkler	Mat Eloksal Elektrostatik Boya

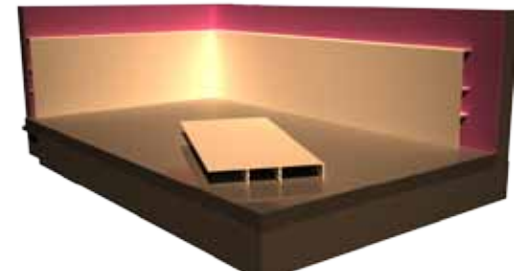
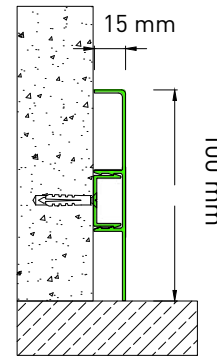

Ürün Kodu	SP 120
Açıklama	120 mm Alüminyum Süpürgelik Profili
Boy	3,00 mt
Renkler	Mat Eloksal Elektrostatik Boya

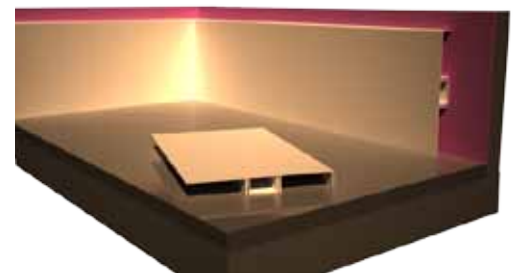
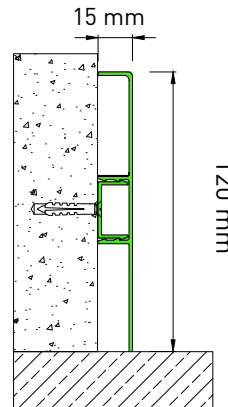

EŞİK PROFİLLERİ

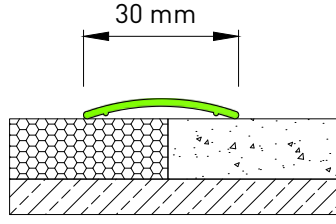

Ürün Kodu	EP 30
Açıklama	30 mm Alüminyum Kapı Eşik Profili
Boy	2,70 mt
Renkler	Mat Eloksal Sarı Eloksal

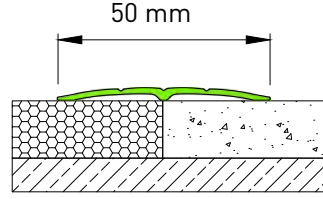

Ürün Kodu	EP 50
Açıklama	50 mm Alüminyum Kapı Eşik Profili
Boy	2,70 mt
Renkler	Mat Eloksal Sarı Eloksal

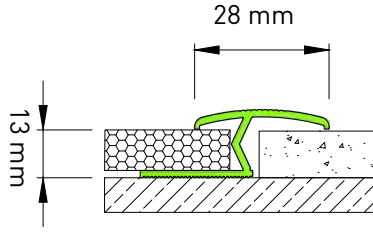

Ürün Kodu	EP Z
Açıklama	Z Eşik Profili
Boy	2,70 mt
Renkler	Mat Eloksal Sarı Eloksal

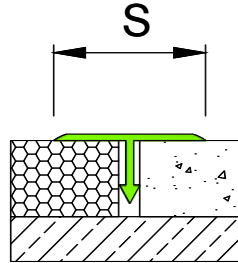
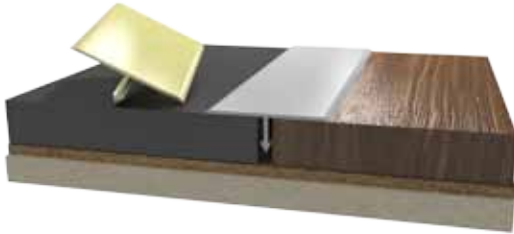

Ürün Kodu	EP T
Açıklama	T Eşik Profili
Genişlik (S)	20 mm - 25 mm - 30 mm
Renkler	Mat Eloksal Sarı Eloksal

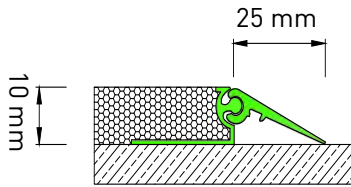

Ürün Kodu	KAKF
Açıklama	Kaplama Altı Kot Farkı Eşik Profili
Boy	2,70 mt
Renkler	Mat Eloksal Sarı Eloksal

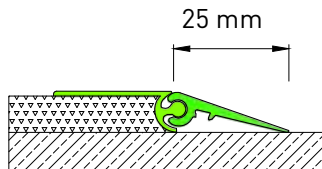

Ürün Kodu	KUKF
Açıklama	Kaplama Üzeri Kot Farkı Eşik Profili
Boy	3,00 mt
Renkler	Mat Eloksal Sarı Eloksal

GENLEŞME VE MERDİVEN BURUN PROFİLLERİ



Ürün Kodu	EP 30
Açıklama	PVC Genleşme Profili
Boy	2,70 mt
Renkler	gri , beyaz , bej

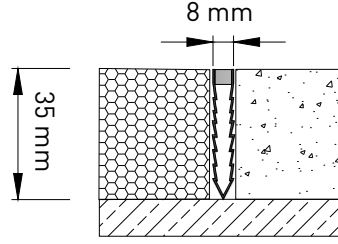

Ürün Kodu	EP 30
Açıklama	PVC Genleşme Profili
Boy	2,70 mt
Renkler	gri , beyaz , bej

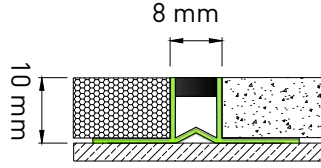

Ürün Kodu	EP 30
Açıklama	Fitilli Alüminyum Genleşme Profili
Boy	3,00 mt
Renkler	gri , beyaz , bej

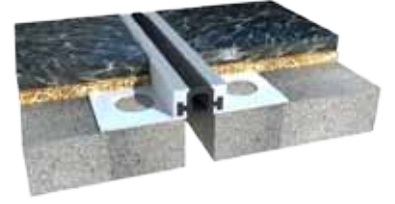
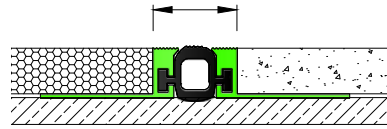

Ürün Kodu	MBP 5530
Açıklama	55 mm x 30 mm Zımparalı Merdiven Burun Profili
Boy	3,00 mt
Renkler	Mat Eloksal Sarı Eloksal

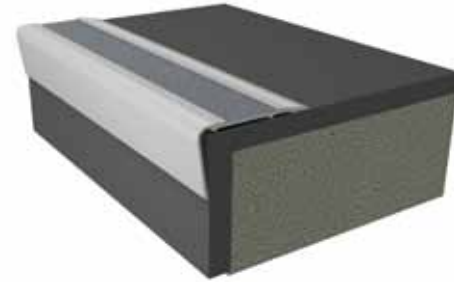
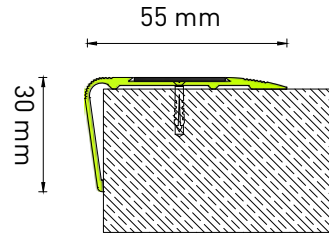

Ürün Kodu	EP 4020
Açıklama	40 mm x 20 mm Merdiven Burun Profili
Boy	3,00 mt
Renkler	Mat Eloksal Sarı Eloksal

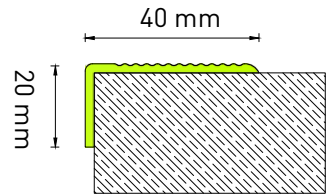

Ürün Kodu	EP 30
Açıklama	Kendinden Yapışkanlı Kaydırmaz Band
Boy	25 mt / top
Genişlik	25 mm - 50 mm

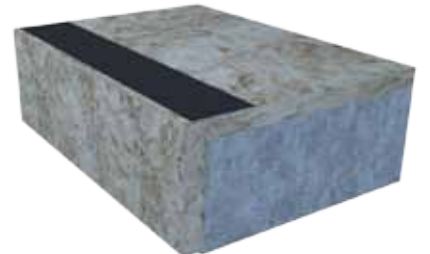



TPE YALITIM BANDI VE EPOKSİ YAPIŞTIRICI

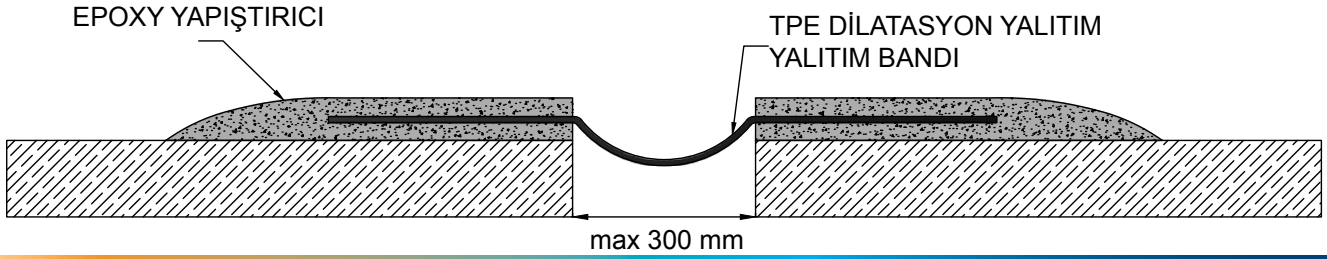
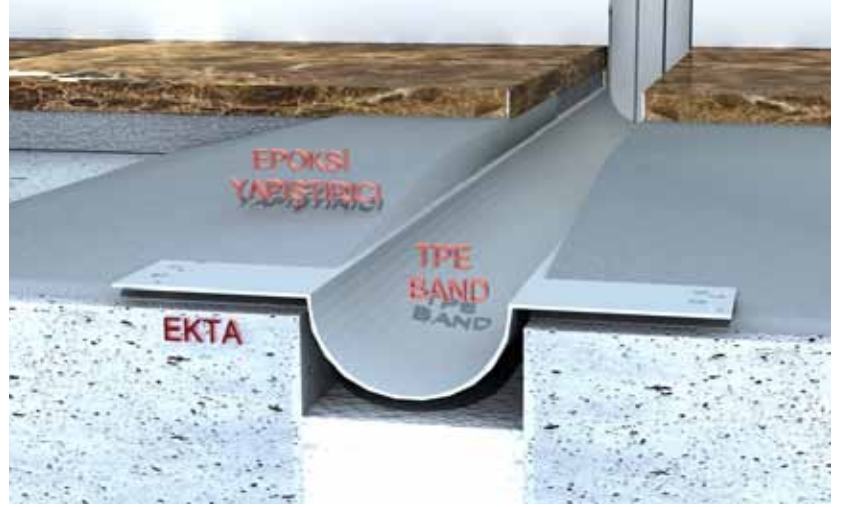
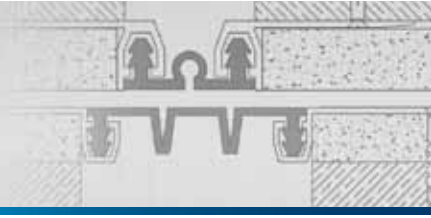

Termoplastik elastomer esaslı TPE Dilatasyon Bandı, her türlü yapı ve genişleme derzlerinin birleşim yerlerinde kullanılan kalıcı elastikiyette dilatasyon bandıdır.

Ambalaj: 25 mt rulo

Kalınlık : 1,00 mm - 1,25 mm - 1,50 mm

Genişlik : 15 cm - 20 cm - 25 cm - 30 cm - 35 cm - 40 cm

EPOKSİ UYGULAMASI :

Epoksi yapıştırıcı iki bileşenlidir. Uygulamadan önce A bileşeni (3,75 kg) ve B Bileşeni (1,25 kg) düşük devirli karıştırıcı ile homojen bir karışım haline gelene kadar karıştırılır. Mala ve spatula yardımı ile dilatasyon yanaklarına takriben 1,00 – 1,50 mm kalınlığında Epoksi yapıştırıcı uygulanır. Uygulama genişliği 20 cm enindeki bant için en az 40 mm, 30 cm enindeki bant için en az 50 mm olmalıdır. Kuvvetli aderans sağlamak için uygulama esnasında yapıştırıcı zemine iyice yedirilmelidir.

TPE BANT UYGULAMASI :

Uygulama yapılacak alanlar tespit edilerek uygun bant boyları hazırlanır, Tpe yapıştırıcı katmanının üzerine serilir ve uygun bir rulo yardımı ile Tpe bant ve yapıştırıcı katmanı arasında tam temas oluşması sağlanır. Benzer şekilde bantın üst yüzeyine epoksi uygulanır. Uygulama 1,00 mm – 1,50 mm kalınlığında ve bantı en az 20 mm taşacak şekilde yapılır, katman sertleşmeye bırakılır. Soğuk havalarda yapıştırıcının kuruma süresinin uzayacağı, sıcak havalarda kısalacağı göz önüne alınmalıdır.



EKTA YAPI

Örnek Mah. Örnek Cad. No:1 Altındağ / ANKARA
Tel: 0312 350 82 27 • Faks: 0312 316 20 36 • E-mail: iletisim@ektayapi.com

www.ektayapi.com
www.dilatasyonprofilleri.com